



2/2-way Angle-Seat Valve for medium up to +180 °C, threaded port connection, DN 15-65

For process valves with decentralized automation see ELEMENT Type 2100

- High flow rate
- Long life cycle
- NC and NO universal actuators with modular universal accessory program up to control heads
- Deliverable with flow direction below or above seat
- Simple conversion of the control function

Type 2000 can be combined with...



Type 8697
Electrical position feedback

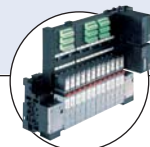

Type 8640/8644
Valve block



Type 6012/6014 P
Pilot valve

The externally piloted angle-seat valve is operated with a single or double-acting piston actuator. The actuator is available in two different materials, PA and PPS depending on the ambient temperature. The reliable self-adjusting packing gland provides high sealing integrity. High flow rates are attained with the gunmetal or cast stainless steel 2-way body. These maintenance-free and robust valves can be retrofitted with a comprehensive range of accessories for position indication, stroke limitation or manual override.

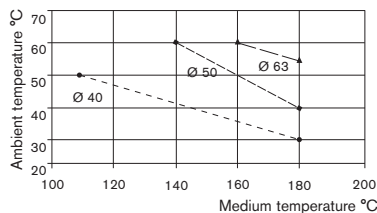

For valves with port connection clamp and weld end please see separate datasheets.

¹⁾ **Note:** For PA actuators in the sizes 40, 50 and 63, the combination of max. medium temperature and max. ambient temperature is as shown in the following chart



Technical data	
Orifice	DN 15 to 65
Body materials	Gunmetal, cast stainless steel 316L
Actuator material	PA or PPS
Seal material	PTFE (NBR, FKM, EPDM on request)
Medium	Water, alcohol, oils, fuel, hydraulic fluids, salt solution, alkali solutions, organic solvents, steam
Viscosity	max. 600 mm ² /s
Packing gland (with silicone grease)	PTFE V-rings with spring compensation
Medium temperature¹⁾	-10 to +180 °C with PTFE seal
Ambient temperature	
PA actuator ¹⁾	-10 to +60 °C
PPS actuator ¹⁾ Ø 40-80	+5 to +140 °C
PPS actuator ¹⁾ Ø 100-125	+5 to +90 °C, briefly up to +140 °C
Installation	As required, preferably with actuator in upright position
Control medium	Neutral gases, air
Max. pilot pressure	
Actuator size Ø 40-80	PA and PPS 10 bar
Actuator size Ø 100	PA 10 bar
Actuator size Ø 100	PPS 7 bar
Actuator size Ø 125	PA and PPS 7 bar
Port connection	G 3/8 to G 2 1/2 (NPT on request)

Content

Valve specifications	System spec. On/Off CLASSIC	Request for quotation
 Type 2000 threaded port	 Type 8801-YA	Type 8801-YA
Technical data & ordering info.	p. 1-7	Ordering info. & technical data p. 8-11
		p. 12

Materials Type 2000 threaded port

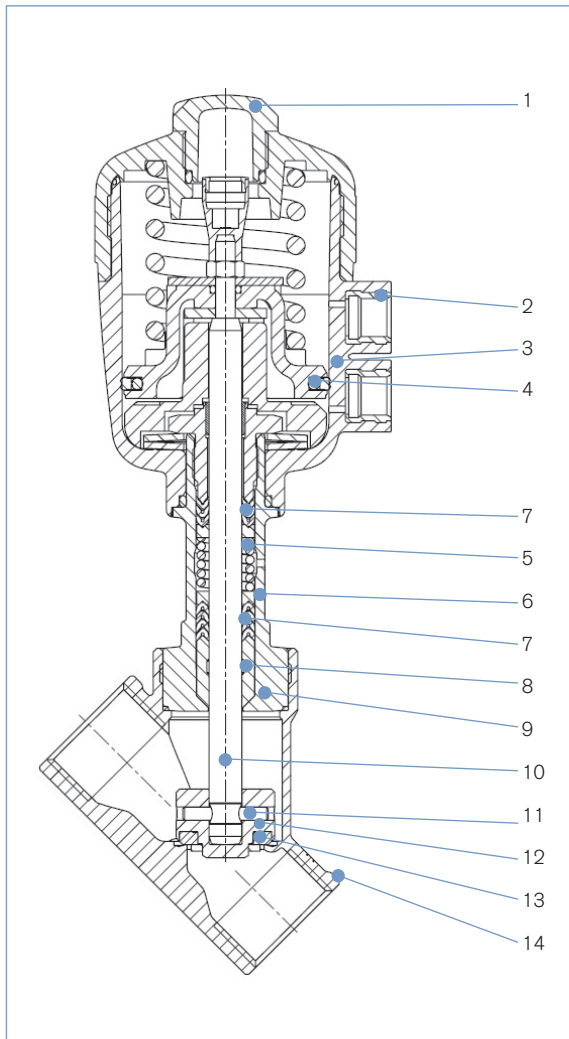

	Gunmetal body	Cast stainless steel body
1 Transparent cap	PC (with PPS actuator; PSU)	PC (with PPS actuator; PSU)
2 Pilot air ports	Brass	Stainless steel 1.4305
3 Actuator	PA, PPS	PA, PPS
4 Piston seal	NBR (with PPS actuator; FKM)	NBR (with PPS actuator; FKM)
5 Spring	Stainless steel 1.4310	Stainless steel 1.4310
6 Tube ²⁾	Brass CuZn	Stainless steel 1.4401 Stainless steel 316L ³⁾
7 V-Seals	PTFE (FKM on request)	PTFE (FKM on request)
8 Wiper	PTFE PEEK ¹⁾	PTFE PEEK ¹⁾
9 Nipple ²⁾	Brass CuZn	Stainless steel 1.4401 Stainless steel 316L ³⁾
10 Spindle	Stainless steel 1.4021	Stainless steel 1.4401
11 Pin	Stainless steel 1.4401	Stainless steel 1.4401
12 Swivel plate	Brass CuZn	Stainless steel 1.4401
13 Seal	PTFE (NBR, FKM, EPDM on request)	PTFE (NBR, FKM, EPDM on request)
14 Valve body	Gunmetal GCuSn5ZnPb2%Ni	Stainless steel 316L

¹⁾ For actuator size 100 mm and 125 mm

²⁾ Single piece with actuator size 63 mm to 125 mm

³⁾ For actuator size 63 mm to 125 mm

Technical data Type 2000 threaded port, flow direction below seat (for gases and liquid)

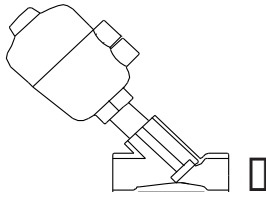

Flow direction below seat

Orifice [mm]	Actuator size [mm]	Kv value water (m ³ /h)	Min. pilot pressure CFA [bar]	Max. operating pressure up to ±180°		Weight [kg]
				CFA [bar]	CFB [bar]	
15	40	3.7	4.0	15	16	0.8
	50	4.2	3.9	16	16	0.8
20	40	7.0	4.0	6.5	16	0.9
	50	8.5	3.9	11	16	1.0
	63	9.0	4.5	16	–	1.4
25	50	10	–	–	16	1.2
	63	18	4.5	11	16	1.8
	80	18	5.0	16	16	2.2
32	63	25	4.5	6	16	2.2
	80	27	5.0	14	16	3.1
40	63	35	–	–	16	2.7
	80	38	5.0	9	16	3.5
	100	40	4.4	12.5	–	7.6
	125	40	3.2	16	–	9.0
50	63	49	–	–	13	4.0
	80	52	–	–	15	4.8
	100	55	4.4	7.2	–	7.0
	125	55	3.2	10	–	9.4
65	80	77	–	–	15	6.4
	125	90	3.2	5.2	–	11.0

Kv value water [m³/h]: Measured at +20 °C, 1 bar pressure at valve inlet and free outlet
 Pressure values [bar]: Measured as overpressure to the atmospheric pressure

Pilot pressure diagram with control function B and flow direction below seat

Diagram 1

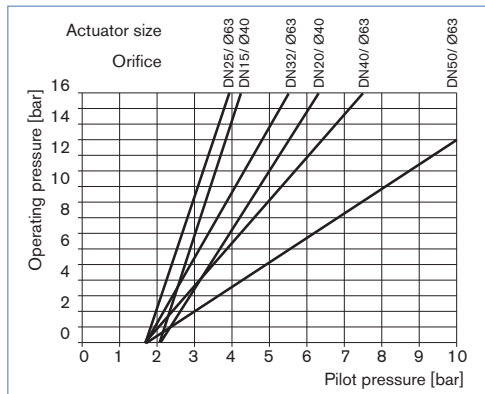
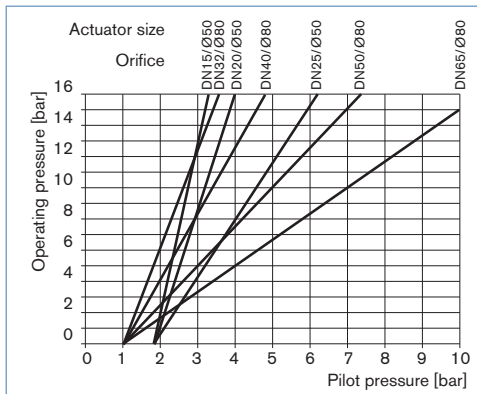
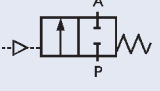
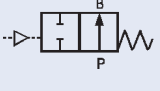

Diagram 2



Ordering chart Type 2000 threaded port, flow direction below the seat (for gases and liquid)

Different actuator and body materials

Control function	Port connection	Orifice [mm]	Actuator size Ø [mm]	Kv value water [m³/h]	Minimum pilot pressure [bar]	Max. operating pressure up to 180 °C [bar]	Gunmetal body		Cast st. st. body	
							Item no. PA actuator	Item no. PPS actuator	Item no. PA actuator	Item no. PPS actuator
A 2/2-way, normally closed (NC) 	G 3/8	15	40	3.7	4.0	15	178 614	178 613	142 613	178 612
	G 1/2		40	3.8	4.0	15	178 608	178 607	178 606	178 605
			50	4.2	3.9	16	178 684	178 683	178 682	178 681
	G 3/4	20	50	8.5	3.9	11	178 680	178 679	178 678	178 677
			63	9.0	4.5	16	178 666	178 665	178 664	178 663
			80	18	5.0	16	186 489	187 565	186 488	187 844
	G 1	25	63	18	4.5	11	178 676	178 675	178 674	178 667
			80	18	5.0	16	186 489	187 565	186 488	187 844
	G 1 1/4	32	80	27	5.0	14	178 699	178 698	178 697	178 696
			125	40	3.2	16	186 487	–	187 840	–
	G 1 1/2	40	80	38	5.0	9	178 695	178 694	178 693	178 692
			125	55.0	3.2	10	001 593	002 171	001 601	–
			150	55.0	3.2	10	001 593	002 171	001 601	–
	G 2	50	100	55.0	4.4	7.2	001 134	002 170	001 140	001 239
125			55.0	3.2	10	001 593	002 171	001 601	–	
150			90.0	3.2	5.2	001 368	002 172	001 373	001 703	
B 2/2-way, normally open (NO) 	G 3/8	15	40	3.7	see diagram 1 and 2 on previous page	16	140 368	178 610	142 616	178 609
	G 1/2		40	3.8		16	178 601	178 602	178 603	178 604
			50	4.2		16	178 691	178 690	178 689	178 688
	G 3/4	20	50	8.5		16	178 687	179 020	178 686	178 685
			63	10		16	178 850	178 849	178 848	178 847
	G 1	25	50	10		16	178 845	178 853	178 852	178 851
			63	25		16	178 845	178 853	178 852	178 851
	G 1 1/4	32	63	25		16	178 845	178 853	178 852	178 851
			80	35		16	178 864	178 863	178 862	178 861
	G 1 1/2	40	63	35		16	178 864	178 863	178 862	178 861
			80	49.0		13	001 371	002 179	001 376	001 709
			100	52		16	001 595	002 180	001 603	002 164
	G 2	50	80	52		16	001 595	002 180	001 603	002 164
			100	77.0		15	001 372	002 181	001 377	001 710

 Further versions on request

Material
Seal: NBR, FKM, EPDM



Control function
Double-acting actuator



Port connections
Clamp, weld end (see separate datasheets)



Approvals
GL, SIL



Mediums temperature
Valves for mediums temperature up to +200 °C or down to -40 °C

Technical data Type 2000 threaded port, flow direction above seat (only for gas and steam)

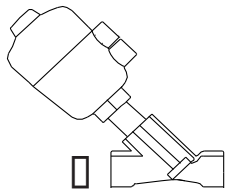

Flow direction above seat

Attention!

Valves with flow direction above the seat are only conditionally usable for liquid medium. There is a danger of waterhammer!

Orifice [mm]	Actuator size [mm]	Kv value water (m ³ /h)	Max. operating pressure up to 180° C	Weight [kg]
15	40	3.7	16	0.8
	50	4.2	16	0.8
20	40	7.9	16	0.9
	50	8.0	16	1.0
25	50	14.5	16	1.2
	63	19.0	16	1.8
32	63	27.0	16	2.2
40	63	35.0	16	2.7
	80	38.0	16	3.5
50	63	49.0	16	4.0
	80	52.0	16	4.8
65	80	77.0	14	6.4
	100	90.0	15	8.6

Kv value water [m³/h]: Measured at +20 °C, 1 bar pressure at valve inlet and free outlet
 Pressure values [bar]: Measured as overpressure to the atmospheric pressure

Technical data	Flow direction above seat (only for gases and steam)
Medium	Gaseous medium and steam
Further technical data	Please see information Technical data on page 1

Pilot pressure diagram with control function A and flow direction above seat

Diagram 3

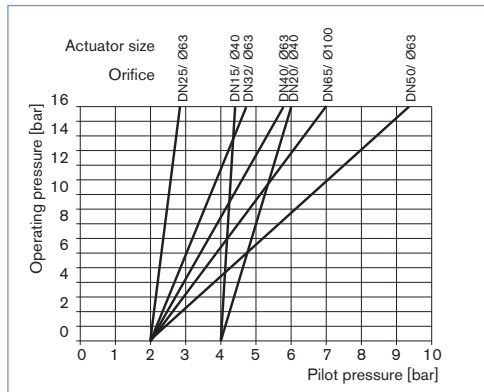
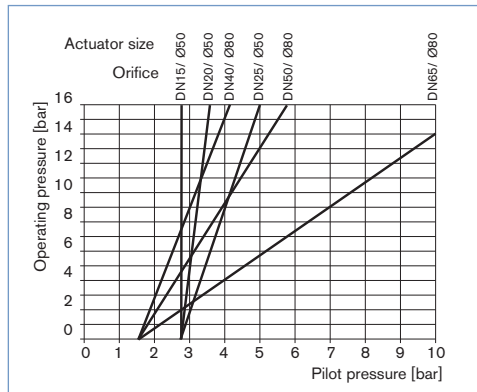

Diagram 4



Ordering chart Type 2000 threaded port, flow direction above the seat (only for gas and steam)

Various actuator and body materials

Minimum pilot pressure depending on operating pressure, please see diagram 3 and 4 on previous page

Control function	Port connection	Orifice [mm]	Actuator size Ø [mm]	Kv value water [m ³ /h]	Max. operating pressure to 180°C [bar]	Gunmetal body		Stainless steel body	
						Item no. PA actuator	Item no. PPS actuator	Item no. PA actuator	Item no. PPS actuator
A 2/2-way, normally closed (NC) 	G 3/8	15	40	3.7	16	186 588	□	142 615	□
	G 1/2		50	4.2	16	183 939	186 106	186 376	186 467
	G 3/4	20	40	7.9	16	186 822	□	187 672	□
			50	8.0	16	185 356	180 374	185 304	180 375
	G 1	25	50	14.5	16	186 380	187 556	186 729	187 872
			63	18.0	16	178 860	178 859	178 857	178 856
	G 1 1/4	32	63	25.0	16	178 855	178 854	178 893	178 892
	G 1 1/2	40	63	35.0	16	178 896	178 897	178 895	178 894
	G 2	50	63	49.0	16	001 251	002 149	001 401	002 158
				77.0	14	001 398	002 151	001 402	002 160
G 2 1/2	65	80	90.0	15	130 332	186 344	130 333	–	
			100	90.0	15	130 332	186 344	130 333	–

□ on request

i Further versions on request

Material
Seal: NBR, FKM, EPDM

Control function
Double-acting actuator

Port connections
Clamp, weld end (see separate datasheets)

Approvals
GL, SIL

Mediums temperature
Valves for mediums temperature up to +200 °C or down to -40 °C

Ordering chart for accessories

3/2-way pilot valves with banjo bolts

Seal material valve FKM, seal material banjo bolt NBR

Valve for actuator size [Ø mm]	Type	Pressure inlet P (valve body)	Service port A (banjo bolt)	Orifice [mm]	Qn value air [l/min]	Pressure range [bar]	Electrical coil connection Ind. Std.	Power consumption [W]	Item no. Voltage/frequency [V/Hz]
50-63	6012P	Tube fitting ø6 mm	G 1/4	1.2	48	0-10	Form B	4	552 283 552 286
40	6012P	G 1/4	G 1/8	1.2	48	0-10	Form B	4	552 295 552 298
50-125	6014P	G 1/4	G 1/4	2	120	0-10	Form A	8	424 103 424 107

Cable plug Type 2507, Form B or Type 2508, Form A

	Item no.
Type 2507, Form B Industrial standard, 0 to 250 V without circuitry (Type 6012 P)	423 845
Type 2508, Form A acc. DIN EN 175301-803, 0 to 250 V without circuitry (Type 6014 P, Type 0331P)	008 376

For further accessories see datasheet for Type 1062 or the accessories datasheet Type 2XXX for the full options programme.

Note: For design reasons, some of the accessories cannot be supplied for actuator size Ø 40 mm. Please request the accessories datasheet Type 2XXX.

Dimensions Type 2000 threaded port [mm]

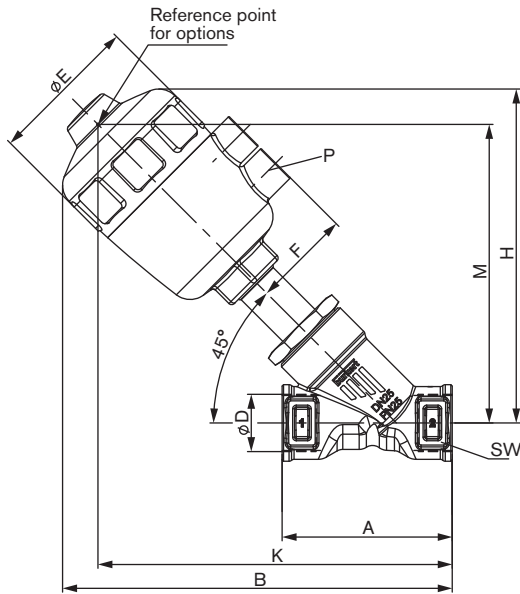

Orifice	Actuator size \varnothing	Port connection D	A	B	$\varnothing E$	H	K	M	P	SW
15	40	G 3/8	65	139	53	115	125	100	G 1/8	27
		G 1/2		139	53	115	125	100	G 1/8	
	50	G 3/8		163	64	140	147	123	G 1/4	
		G 1/2		163	64	140	147	123	G 1/4	
20	40	G 3/4	75	147	53	120	133	106	G 1/8	34
	50			171	64	144	155	129	G 1/4	
	63			198	80	171	179	152	G 1/4	
25	50	G 1	90	181	64	152	166	136	G 1/4	41
	63			206	80	177	188	158	G 1/4	
	80			228	101	198	204	173	G 1/4	
32	63	G 1 1/4	110	219	80	183	200	164	G 1/4	50
	80			240	101	205	217	180	G 1/4	
	100			292	127	255	261	226	G 1/4	
40	63	G 1 1/2	120	222	80	188	203	170	G 1/4	55
	80			244	101	209	220	185	G 1/4	
	100			295	127	260	264	230	G 1/4	
	125			324	158	289	287	253	G 1/4	
50	63	G 2	150	249	80	204	230	185	G 1/4	70
	80			270	101	225	246	201	G 1/4	
	100			317	127	272	287	242	G 1/4	
	125			347	158	302	310	265	G 1/4	
65	63	G 2 1/2	185	275	80	218	256	199	G 1/4	85
	80			296	101	239	272	215	G 1/4	
	100			344	127	287	314	257	G 1/4	
	125			374	158	317	337	280	G 1/4	

2000 threaded port System On/Off CLASSIC 8801-YA

bürkert

Ordering information for valve system On/Off CLASSIC Type 8801-YA

An **angle seat valve Type 2000** can be combined with the **feedback Type 8697** to form a **valve system On/Off CLASSIC**.

The valve system On/Off CLASSIC is composed of:

- a feedback Type 8697 (see separate datasheet)
- an angle seat valve Type 2000 (see ordering chart p. 3)

More info.

For the configuration of further valve systems please use the "Request for quotation" on p. 10. [go to page](#)

You order two components and receive a complete assembled and certified valve.

Angle seat valve Type 2000 threaded



Feedback Type 8697



Valve System On/Off CLASSIC



Type 8801-YA-U
2000 + 8697

Electrical position feedback

More info.



Type 8697

Actuator size 40 to 225

The pneumatic control unit Type 8697 is designed for integrated mounting on CLASSIC series 20XX process valves suiting the requirements of hygienic process environment Mechanical or inductive limit switches register the position of the valve.

Features

- Compact design
- LED position indicator
- Mechanical or inductive limit switches for end position registering
- Easy to clean chemically resistant housing featuring IP65 / IP67, 4X Rating
- Optional intrinsically safe version acc. to ATEX

Benefits

- Easy and quick installation
- High level of signal reliability thanks to self adjusting limit switches
- Signal safety through the automatic adjustment of the limit switches
- Minimised space requirement in the plant piping for more flexibility in plant design

Click on the orange box „More info“... you will come to our website for the resp. product where you can download the data sheet.

Dimensions for valve system On/Off Classic Type 8801-YA [mm]

Dimensions valve system On/Off Classic Type 8801-YA-U with TopControl Type 8697

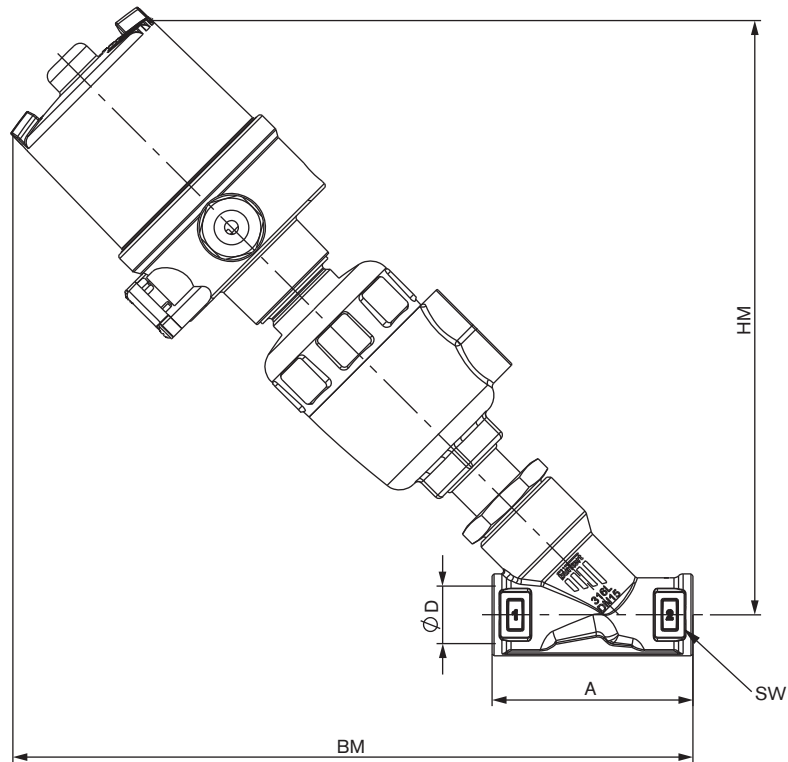

Orifice [mm]	Actuator size Ø [mm]	BM [mm]	HM [mm]	A [mm]	øD [mm]	SW [mm]
15	40	220	197	65	G 3/8	27
	40	220	197	65	G 1/2	
	50	215	239	65	G 3/8	
20	50	247	220	75	G 3/4	34
	63	279	244	75		
25	63	279	250	90	G1	41
	80	295	266	90		
32	80	310	274	110	G1 1/4	50
	125	379	344	120		
40	80	311	276	120	G1 1/2	55
	125	379	344	120		
50	100	370	325	150	G2	70
	125	386	344	150		
65	125	415	358	185	G2 1/2	85

Valve system On/Off Classic Type 8801-YA – request for quotation

Please fill out and send to your nearest Bürkert facility* with your inquiry or order

Company	Contact person
Customer no.	Department
Address	Tel./Fax
Postcode/town	E-Mail

= mandatory fields to fill out

Quantity

Required delivery date

Operating data

Pipeline	DN	<input type="text"/>	PN	<input type="text"/>
Pipe material	<input type="text"/>			
Process medium	<input type="text"/>			
Type of medium	<input type="checkbox"/> Liquid	<input type="checkbox"/> Steam	<input type="checkbox"/> Gas	
	standard	unit		
Flow rate (Q, Q _N , W) ¹⁾	<input type="text"/>	<input type="text"/>		
Temperature at valve inlet	<input type="text"/>	<input type="text"/>		
Absolute pressure at valve inlet	<input type="text"/>	<input type="text"/>		

¹⁾ standard unit: Liquid Q = m³/h; Steam W = kg/h; Gas Q_N = Nm³/h

Valve features

Actuator material	<input type="checkbox"/> PA	<input type="checkbox"/> PPS
Body material	<input type="checkbox"/> Stainless steel	<input type="checkbox"/> Gunmetal
Seat sealing material	<input type="checkbox"/> PTFE <input type="checkbox"/> NBR	<input type="checkbox"/> Other <input type="text"/>
Nominal pressure	PN <input type="text"/>	
Nominal size	DN <input type="text"/>	
Type of connection	<input type="checkbox"/> Welded <input type="checkbox"/> Internal thread <input type="checkbox"/> Clamp	
Standard connection	<input type="checkbox"/> ISO <input type="checkbox"/> DIN <input type="checkbox"/> ANSI <input type="checkbox"/> JIS <input type="checkbox"/> Other <input type="text"/>	
Function	<input type="checkbox"/> NC ²⁾ <input type="checkbox"/> NO ²⁾ <input type="checkbox"/> Double-acting	
Pilot pressure	<input type="text"/> min.	<input type="text"/> max.

²⁾ NC: normally closed by spring action; NO: normally open by spring action

Automation unit features

Click on the orange box „More info“... you will come to our website for the resp. product where you can download the data sheet.

Electrical position feedback

Type 8697
For actuator size 40 to 225



- LED position indicator
- Mechanical or inductive limit switches for end position registering
- Housing with IP65/IP67, 4X rating protection
- Optional intrinsically safe version acc. to ATEX / IECEx

Position feedback switches

- Micro switch 24V DC
- Micro switch 50 – 225 V DC/AC
- Inductive switch 3-wire PNP
- Inductive switch 2-wire NAMUR
- Inductive switch 2-wire 24V DC

Electrical connection

- Cable gland
- M12 connector
(applicable only with inductive switch 3-wire PNP)

Number of Position feedback switches

- 2x

Approval

- ATEX cat. 3GD, IECEx
- ATEX cat. 2DG, IECEx
- without

Valve system On/Off Classic Type 8801-YA – request for quotation, *continued*

Valve accessories	
Pilot valve	Stroke limitation
<input type="checkbox"/> Pilot valve	<input type="checkbox"/> Stroke limitation
Power supply <input type="text"/>	<input type="checkbox"/> Min./max. stroke limitation , with visual position indicator
	<input type="checkbox"/> Max. stroke limitation , without visual position indicator
Please specify item no. if known: <input type="text"/>	Please specify item no. if known: <input type="text"/>

Certifications
<input type="checkbox"/> Attestation of compliance with the order EN-ISO 10204 2.1
<input type="checkbox"/> Test report EN-ISO 10204 2.2
<input type="checkbox"/> Certification of Conformity for Raw Material EN-ISO 10204 3.1
<input type="checkbox"/> EN161 (European Gas Device guideline)

Comment / sketch

DTS 1000100997 EN Version: U Status: RL (released | freigegeben | valide) printed: 09.05.2016

*To find your nearest Bürkert facility, click on the orange box → www.burkert.com