

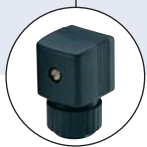

Type 6213EV can be combined with...



Type 2508

Cable plug

Servo-assisted 2/2-way diaphragm valve

- Servo-assisted diaphragm with diameter of up to DN 40
- Spring coupled diaphragm opens without differential pressure
- Vibration-proof, screwed coil system
- Damped design for quiet closing
- Press mould housing with high surface quality

The 6213 EV valve is a servo-assisted solenoid valve of the S.EV series. The spring coupling of the diaphragm supports the opening process of the valve. In its standard version, the valve is suitable for use in liquids. A minimum differential pressure is required for complete opening. A special version (HP00) which opens the valve without differential pressure is available for gas and vacuum applications. Various diaphragm material combinations are available depending on the application. The standard brass housing satisfies all European drinking water requirements. Lead-free or dezincification-resistant brass types are available for other markets. The housing offering is rounded out by a stainless steel version. The solenoid coils are moulded with a chemically resistant epoxy. For reduced energy requirement, all coils can be delivered with electronic power reduction. In combination with a plug in accordance with DIN EN 17301-803 Form A, the valves satisfy protection class IP65 – in combination with a stainless steel housing NEMA 4X.

Circuit function A

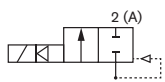

Servo-assisted 2/2-way valve; normally closed, with 2-way pilot control

Technical data	
Orifice	Standard DN 10 - 40 mm HP00: DN13-20
Body material	Brass acc. to DIN EN 50930-6, stainless steel 1.4408 (316), nickel-plated brass (5µm)
Inner part of valve	Brass body: Brass, stainless steel and PPS Stainless steel body: Stainless steel and PPS
Seal material	NBR, FKM, EPDM
Medium	NBR: Neutral fluids, water, hydraulic oil, oil without additives FKM: Per-solutions, hot oils with additives EPDM: Oil and fat-free fluids and gases
Ambient temperature	Max. +55 °C
Medium temperature	NBR: -10 to +80 °C FKM: 0 to +90 °C with polyamide coil / 0 - 120 °C with epoxy coil EPDM: -30 to +90 °C with polyamide coil / -30 to +100 °C with epoxy coil
Voltages	Standard 024/DC, 024/50, 230/50, 110/50, 120/60 HP00: 24V (50-60Hz), 230V (50-60Hz)
Voltage tolerance	±10%
Duty cycle	100% continuous rating
Electrical connection	Tag connector acc. to DIN EN 175301-803 Form A (previously DIN 43650) (see ordering chart for accessories, page 7)
Protection class	IP 65 with cable plug
Installation	As required, preferably with actuator upright

Response times¹⁾	0.1 - 4 seconds (depending on orifice and differential pressure)
------------------------------------	---

¹⁾ Measured at valve outlet at 6 bar and +20°C
 Opening: pressure build-up 0 to 90%
 Closing: Pressure drop 100 to 10%

Technical data

Power consumption

Orifice DN	Port Connection	Coil size width [mm]		Power consumption ¹⁾			Insulation class coil ²⁾		Weight [kg]	
		AC	DC	Inrush AC [VA]	Hold (hot coil) AC [VA/W]	DC [W]	Seal material FKM	Seal material NBR and EPDM	Brass Coil AC	Brass Coil DC
10	G1/4, G3/8	32	40	34	14/8	10 (11)	H	B	0.33	0.41
10	G1/2	32	40	34	14/8	10 (11)	H	B	0.37	0.44
13	G1/2	32	40	36	14/8	10 (11)	H	B	0.46	0.54
13	G3/4	32	40	36	14/8	10 (11)	H	B	0.49	0.57
20	G3/4	32	40	38	14/8	10 (11)	H	B	0.74	0.82
20	G1	32	40	38	14/8	10 (11)	H	B	0.95	1.03
25	G1	42	65	150	37/16	28 (29)	H	H	1.6	2.2
25	G11/4	42	65	150	37/16	28 (29)	H	H	1.7	2.3
40	G11/2	42	65	190	37/16	28 (29)	H	H	3.2	3.7
40	G2	42	65	190	37/16	28 (29)	H	H	3.38	3.9

HP00 Power consumption

Orifice DN	Port Connection	Coil size width [mm] AC/DC	Power consumption ¹⁾			Insulation class coil ²⁾		Weight [kg]	
			Inrush AC [VA]	Hold (hot coil) AC [VA/W]	DC [W]	Seal material FKM	Seal material NBR and EPDM	Brass Coil AC	Brass Coil DC
13	G1/2	42	125	37/16	16 (21)	H	H	0.80	0.81
13	G3/4	42	125	37/16	16 (21)	H	H	0.86	0.87
20	G3/4	42	140	37/16	16 (21)	H	H	1.13	1.14
20	G1	42	140	37/16	16 (21)	H	H	1.30	1.31

¹⁾ Values in brackets applies at coil temperature 20 °C

²⁾ H Epoxy coil, B Polyamide coil

Materials

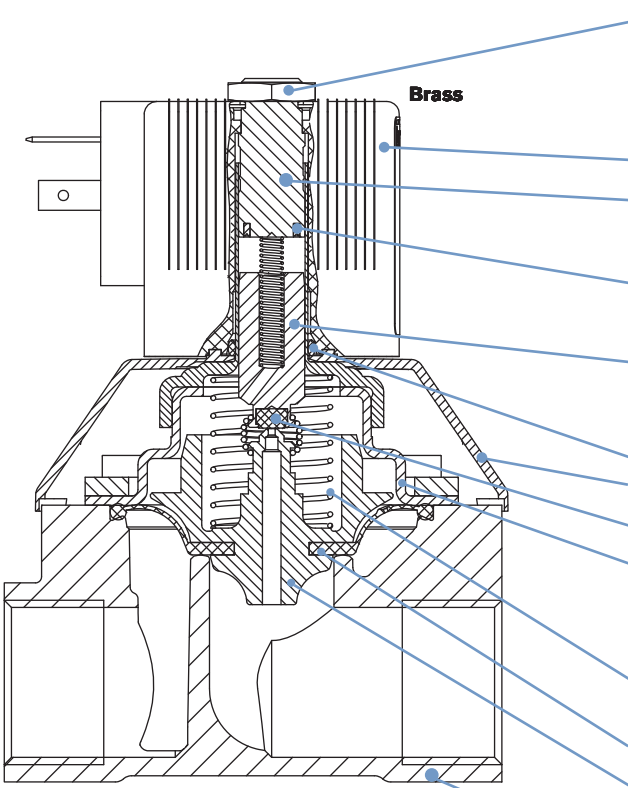

Locknut:	Brass version:	Steel (surface thick-film passivated acc. to Rohs)
	Stainless steel version:	1.4305 PTFE coated
Coil:		Polyamide or Epoxy
Stopper:	DN 10-40 mm:	1.4113
Shading ring (only AC version):	with Brass body:	Copper (Cu)
	with Stainless steel body:	Silver (Ag)
Magnetic core:	DN 10-40 mm:	1.4113
O-Ring:		FKM
Bonnet:		PA6
Plunger seal:		NBR, FKM, EPDM
Cover:	DN 10-25 mm	1.4301
	DN 40	Brass, nickel-plated brass (5µm), stainless steel 1.4408
Spring:		1.4310
Diaphragm		NBR, FKM, EPDM
Diaphragm support:		PPSGF40 in combination with brass and accordingly stainless steel parts
Valve body:		Brass, nickel-plated brass(5µm), stainless steel 1.4408

Dimensions [mm]

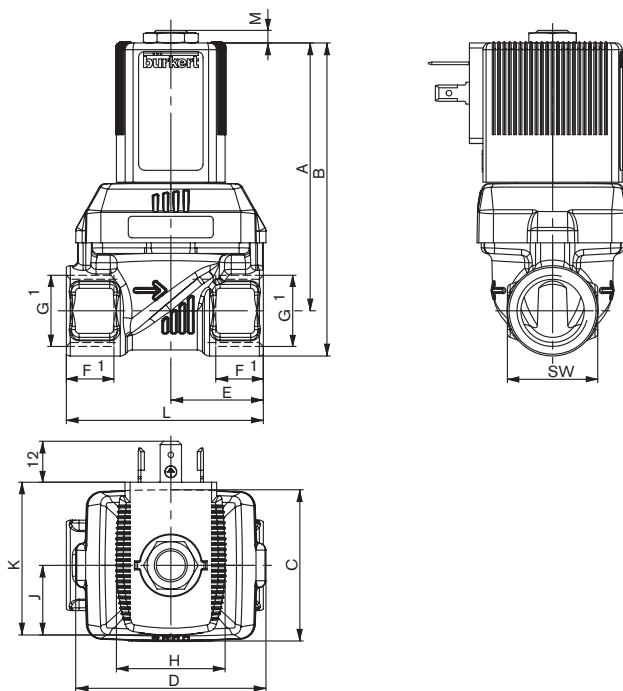

Dimensions (AC-coil, 32mm)

DN	A	B	C	D	E (MS/VA)	* G F1 G1	* NPT F2 G2	* Rc F3 G3	H	J	K	L (MS/VA)	SW	M		
10	67.4	78.4	36	46	22	12 G 1/4	10 NPT 1/4	9.7 Rc 1/4	32	20.5	45	50	22	3.7		
	67.4	78.4			22	12 G 3/8	10.3 NPT 3/8	10.1 Rc 3/8							50/55	27
	69.4	82.9			24.5	14 G 1/2	13.7 NPT 1/2	13.2 Rc 1/2							58/65	27
13	78.9	92.4	44.5	56	27.2/32.5	14 G 1/2	13.7 NPT 1/2	13.2 Rc 1/2	32	20.5	45	65	32	3.7		
	80.9	96.9			32.5	16 G 3/4	14 NPT 3/4	14.5 Rc 3/4							80	32
20	93.4	109.4	65	76	37	16 G 3/4	14 NPT 3/4	14.5 Rc 3/4	32	20.5	45	80	41	3.7		
	95.9	116.4			37.5	18 G 1	16.8 NPT 1	16.8 Rc 1							80	41

Dimensions (DC-coil, 40mm)

DN	A	B	C	D	E (MS/VA)	* G F1 G1	* NPT F2 G2	* Rc F3 G3	H	J	K	L (MS/VA)	SW	M		
10	67.4	78.4	36	46	22	12 G 1/4	10 NPT 1/4	9.7 Rc 1/4	40	23.5	51	50	22	3.7		
	67.4	78.4			22	12 G 3/8	10.3 NPT 3/8	10.1 Rc 3/8							50/55	27
	69.4	82.9			24.5	14 G 1/2	13.7 NPT 1/2	13.2 Rc 1/2							58/65	27
13	79.3	92.8	44.5	56	27.2/32.5	14 G 1/2	13.7 NPT 1/2	13.2 Rc 1/2	40	23.5	51	65	32	3.7		
	81.3	97.3			32.5	16 G 3/4	14 NPT 3/4	14.5 Rc 3/4							80	32
20	93.8	109.8	65	76	37	16 G 3/4	14 NPT 3/4	14.5 Rc 3/4	40	23.5	51	80	41	3.7		
	96.3	116.8			37.5	18 G 1	16.8 NPT 1	16.8 Rc 1							80	41

Dimensions (AC-coil, 42mm / DC-coil 65mm)

DN	A	B	C	D	E (MS/VA)	* G F1 G1	* NPT F2 G2	* Rc F3 G3	H	J	K	L (MS/VA)	SW	M
40	158.3	193.3	104.5	117	64	24 G 2	17.6 NPT 2	23.4 Rc 2	65	37.5	72	132	70	7
	152.3	182.3			61	22 G1 1/2	17.3 NPT 1 1/2	19.1 Rc 1 1/2						
25	141.3	166.3	77	88	46	20 G1 1/4	17.3 NPT 1 1/4	19.1 Rc 1 1/4	65	37.5	72	95	50	7
	136.3	156.8			46	18 G 1	16.8 NPT 1	16.8 Rc 1						
40	158.3	193.3	104.5	117	64	24 G 2	17.6 NPT 2	23.4 Rc 2	42	27	55.5	132	70	7
	152.3	182.3			61	22 G1 1/2	17.3 NPT 1 1/2	19.1 Rc 1 1/2						
25	141.3	166.3	77	88	46	20 G1 1/4	17.3 NPT 1 1/4	19.1 Rc 1 1/4	42	27	55.5	95	50	7
	136.3	156.8			46	18 G 1	16.8 NPT 1	16.0 Rc 1						

Dimensions [mm] (cont.)

HP00 Version
Dimensions (coil, 42mm)

DN	A	B	C	D	2E	* G		* NPT		* Rc		H	J	K	L	SW	M
					(MS/VA)	F1	G1	F2	G2	F3	G3				(MS/VA)		
20	119.3	139.8	65	76	37.5	18	G 1	16.8	NPT 1	16.8	Rc 1				80	41	
	116.8	132.8			37	16	G 3/4	14	NPT 3/4	14.5	Rc 3/4					32	
13	104.3	120.3	44.5	56	32.5	16	G 3/4	14	NPT 3/4	14.5	Rc 3/4	42	27	55.5	65	32	7
	102.6	115.6			27.2/32.5	14	G 1/2	13.7	NPT 1/2	13.2	Rc 1/2				58/65	27	
					27.2/32.5										58/65	27	

Ordering chart for valves (other versions on request)

Valves with brass body

DN 10 -40 mm ⁴⁾

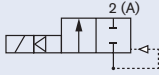
Circuit function	Port connection	Orifice [mm]	Kv value water [m ³ /h] ¹⁾	Pressure range [bar] ²⁾	Weight [kg] (DC) ³⁾	Item no. per voltage/frequency [V/Hz]			
						024/DC	024/50	230/50	
A 2/2-way valve NC 	Brass-body, NBR Diaphragm, polyamide coil, medium temperature -10...+80°C								
	G 1/4	10	1.3	0 - 10	0.3 (0.5)	221 674	221 675	221 677	
	G 3/8	10	1.9	0 - 10	0.3 (0.5)	221 598	221 599	221 601	
	G 1/2	10	1.9	0 - 10	0.4 (0.5)	221 606	221 607	221 609	
	G 1/2	13	3.6	0 - 10	0.4 (0.5)	221 602	221 603	221 605	
	G 3/4	13	3.6	0 - 10	0.5 (0.6)	221 618	221 619	221 621	
	G 3/4	20	8.3	0 - 10	0.7 (0.8)	221 630	221 631	221 633	
	G 1	20	8.3	0 - 10	0.9 (1.0)	221 634	221 635	221 637	
	Brass-body, NBR Diaphragm, epoxy coil, medium temperature -10...+80°C								
	G 1	25	11	0 - 10	1.6 (2.2)	227 533	221 725	221 728	
	G 1 1/4	25	11	0 - 10	1.7 (2.3)	227 534	221 729	221 732	
	G 1 1/2	40	30	0 - 10	3.2 (3.7)	227 539	221 750	221 753	
	G 2	40	30	0 - 10	3.4 (3.9)	227 541	221 754	221 757	
	Brass-body, FKM Diaphragm, epoxy coil, medium temperature 0...120°C								
	G 1/4	10	1.3	0 - 10	0.3 (0.5)	221 678	221 679	221 681	
	G 3/8	10	1.9	0 - 10	0.3 (0.5)	221 610	221 611	221 613	
	G 1/2	10	1.9	0 - 10	0.4 (0.5)	221 614	221 615	221 617	
	G 1/2	13	3.6	0 - 10	0.4 (0.5)	221 622	221 623	221 625	
	G 3/4	13	3.6	0 - 10	0.5 (0.6)	221 626	221 627	221 629	
	G 3/4	20	8.3	0 - 10	0.7 (0.8)	221 638	221 639	221 641	
	G 1	20	8.3	0 - 10	0.9 (1.0)	221 642	221 643	221 645	
	G 1	25	11	0 - 10	1.6 (2.2)	227 537	221 733	221 736	
	G 1 1/4	25	11	0 - 10	1.7 (2.3)	227 538	221 737	221 740	
	G 1 1/2	40	30	0 - 10	3.2 (3.7)	227 544	227 724	227 726	
	G 2	40	30	0 - 10	3.4 (3.9)	227 545	227 728	227 730	
	Brass-body, EPDM Diaphragm, polyamide coil, medium temperature -30...+90°C								
	G 1/4	10	1.3	0 - 10	0.3 (0.4)	221 670	221 671	221 673	
	G 3/8	10	1.9	0 - 10	0.3 (0.4)	221 646	221 647	221 649	
	G 1/2	10	1.9	0 - 10	0.4 (0.5)	221 650	221 651	221 653	
	G 1/2	13	3.6	0 - 10	0.4 (0.5)	221 654	221 655	221 657	
	G 3/4	13	3.6	0 - 10	0.5 (0.6)	221 658	221 659	221 661	
	G 3/4	20	8.3	0 - 10	0.7 (0.8)	221 662	221 663	221 665	
	G 1	20	8.3	0 - 10	0.9 (1.0)	221 666	221 667	221 669	
	Brass-body, EPDM Diaphragm, epoxy coil, medium temperature -30...+100°C								
	G 1	25	11	0 - 10	1.6 (2.2)	227 535	221 717	221 720	
	G 1 1/4	25	11	0 - 10	1.7 (2.3)	227 536	221 721	221 724	
G 1 1/2	40	30	0 - 10	3.2 (3.7)	227 542	221 741	221 745		
G 2	40	30	0 - 10	3.4 (3.9)	227 543	221 746	221 749		

DN 13-20 mm HPOO version

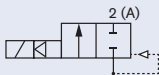
Circuit function	Port connection	Orifice [mm]	Kv value water [m ³ /h] ¹⁾	Pressure range [bar] ²⁾	Weight [kg] (DC) ³⁾	Item no. per voltage/frequency [V/Hz]			
						024/DC ³⁾	024/50-60	230/50-60	
A 2/2-way valve NC 	Brass-body, FKM Diaphragm, epoxy coil, medium temperature 0...+120°C								
	G 1/2	13	3.6	0 - 10	0.8	221 706	221 705	231 574	
	G 3/4	20	8.3	0 - 10	1.3	221 712	221 711	221 713	
	G 1	20	8.3	0 - 10	1.4	221 715	221 714	221 716	
	Brass-body, EPDM Diaphragm, epoxy coil, medium temperature -30...+100°C								
	G 1/2	13	3.6	0 - 10	0.8	221 694	221 693	221 695	
	G 3/4	20	8.3	0 - 10	1.3	208 422	221 699	189 592	
	G 1	20	8.3	0 - 10	1.4	221 703	221 702	221 704	

¹⁾ Measured at +20°C, 1 bar ²⁾ pressure at valve inlet and free outlet.²⁾ Pressure data [bar]: Overpressure with respect to atmospheric pressure.³⁾ The values in brackets regarding the weight apply to the DC version.⁴⁾ A minimum differential pressure of 0.5 bar is required for full (100%) opening.

Ordering chart for valves (other versions on request)

Valves with Stainless steel body;

DN 10 -40 mm ⁴⁾

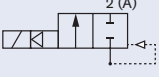
Circuit function	Port connection	Orifice [mm]	Kv value water [m ³ /h] ¹⁾	Pressure range [bar] ²⁾	Weight [kg] (DC) ³⁾	Item no. per voltage/frequency [V/Hz]			
						024/DC ³⁾	024/50	230/50	
A 2/2-way valve NC 	Stainless steel-body, NBR Diaphragm, polyamide coil, medium temperature -10...80°C								
	G 3/8	10	1.9	0 - 10	0.3 (0.4)	222 150	222 151	222 152	
	G 1/2	13	3.6	0 - 10	0.4 (0.5)	222 156	222 157	222 158	
	G 3/4	20	8.3	0 - 10	0.7 (0.8)	222 168	222 169	222 170	
	G 1	20	8.3	0 - 10	0.9 (1.0)	222 171	222 172	222 173	
	Stainless steel body, NBR Diaphragm, epoxy coil, medium temperature -10...+80°C								
	G 1	25	11	0 - 10	1.6 (2.2)	227 546	228 429	222 193	
	G 1 1/4	25	11	0 - 10	1.7 (2.3)	227 547	228 432	222 197	
	G 1 1/2	40	30	0 - 10	3.2 (3.7)	227 552	228 435	222 201	
	G 2	40	30	0 - 10	3.4 (3.9)	227 554	228 438	222 205	
	Stainless steel body, FKM Diaphragm, epoxy coil, medium temperature 0...120°C								
	G 3/8	10	1.9	0 - 10	0.3 (0.4)	221 758	221 759	221 761	
	G 1/2	13	3.6	0 - 10	0.4 (0.5)	221 762	221 763	221 765	
	G 3/4	20	8.3	0 - 10	0.7 (0.8)	222 122	222 123	222 125	
	G 1	20	8.3	0 - 10	0.9 (1.0)	222 126	222 127	222 129	
	G 1	25	11	0 - 10	1.6 (2.2)	227 550	228 430	222 143	
	G 1 1/4	25	11	0 - 10	1.7 (2.3)	227 551	228 433	222 145	
	G 1 1/2	40	30	0 - 10	3.2 (3.7)	227 557	228 436	222 147	
	G 2	40	30	0 - 10	3.4 (3.9)	227 558	228 439	222 149	
	Stainless steel-body, EPDM Diaphragm, polyamide coil, medium temperature -30...90°C								
	G 3/8	10	1.9	0 - 10	0.3 (0.4)	222 153	222 154	222 155	
	G 1/2	13	3.6	0 - 10	0.4 (0.5)	222 159	222 160	222 161	
	G 3/4	20	8.3	0 - 10	0.7 (0.8)	222 174	222 175	222 176	
	G 1	20	8.3	0 - 10	0.9 (1.0)	222 177	222 178	222 179	
	Stainless steel-body, EPDM Diaphragm, epoxy coil, medium temperature -30...+100°C								
	G 1	25	11	0 - 10	1.6 (2.2)	227 548	228 431	222 195	
	G 1 1/4	25	11	0 - 10	1.7 (2.3)	227 549	228 434	222 199	
	G 1 1/2	40	30	0 - 10	3.2 (3.7)	227 555	228 437	222 203	
G 2	40	30	0 - 10	3.4 (3.9)	227 556	228 440	222 207		



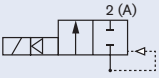

DN 13-20 mm HPOO version

Circuit function	Port connection	Orifice [mm]	Kv value water [m ³ /h] ¹⁾	Pressure range [bar] ²⁾	Weight [kg] (DC) ³⁾	Item no. per voltage/frequency [V/Hz]			
						024/DC ³⁾	024/50-60	230/50-60	
A 2/2-way valve NC 	Stainless steel body, FKM Diaphragm, epoxy coil, medium temperature 0...120°C								
	G 1/2	13	3.6	0 - 10	0.8	208 694	220 585	205 351	
	G 3/4	20	8.3	0 - 10	1.3	222 137	222 136	222 138	
	G 1	20	8.3	0 - 10	1.4	222 140	222 139	222 141	
	Stainless steel-body, EPDM Diaphragm, epoxy coil, medium temperature 0...100°C								
	G 1/2	13	3.6	0 - 10	0.8	213 132	222 166	220 584	
	G 3/4	20	8.3	0 - 10	1.3	222 186	222 187	222 188	
	G 1	20	8.3	0 - 10	1.4	222 189	222 190	222 191	

¹⁾ Measured at +20°C, 1 bar ²⁾ pressure at valve inlet and free outlet.²⁾ Pressure data [bar]: Overpressure with respect to atmospheric pressure.³⁾ The values in brackets regarding the weight apply to the DC version.⁴⁾ A minimum differential pressure of 0.5 bar is required for full (100%) opening.

Please note that the cable plug has to be ordered separately, see Ordering chart for accessory and separate datasheet, Type 2508

i Further versions on request

-  **Port connection**
NPT, Rc
-  **Temperature**
Special temperature ranges
-  **Voltages**
further Voltages available
-  **Body material**
Brass dezincification resistant
nickel-plated brass (5µm)

-  **Approvals**
drinking water approval acc. to KTW/W270
VDE Approval acc. to DIN EN 60730 (VDE0631)
Watermark Licence
UL(UL-listed) approval (MH10753)
UR(UL-recognized) approval
NEMA 250 Type 4X

Orifice DN10 in brass and stainless steel is also available in explosion proof version
Explosion protected approvals
 ATEX: PTB 14 ATEX 2023 X
 II 2G Ex mb IIC T4 Gb
 II 2D Ex mb IIIC T135 °C Db
 IECEx: IECEx PTB 14.0049 X
 Ex mb IIC T4 Gb
 Ex mb IIIC T135 °C Db

Ordering chart for accessories

Cable plug Type 2508 according to DIN EN 175301-803 Form A

	Circuitry	Voltage / frequency	Item no.
	None (standard)	0 - 250 V AC/DC	008 376
	further versions see datasheet Type 2508		

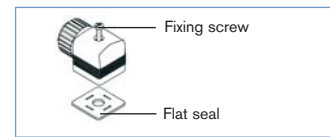

The delivery of a cable plug includes the flat seal and the fixing screw.
 For further versions see datasheet Type 2508

DTS 1000115690 EN Version: J Status: RL (released | freigegeben | valide) printed: 24.03.2015

To find your nearest Bürkert facility, click on the orange box → www.buerkert.com