

## Screw-in Temperature Sensor/Switch with display for On/Off Control

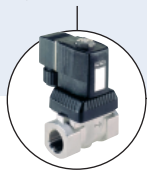

Type 8400 can be combined with...



**Type 6213**

Solenoid valve



**Type 2731 (1067)**

Continuous  
SideControl

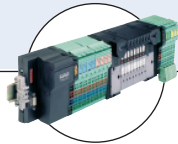

**Type 8644-P AirLINE**

Valve island with  
electronic I/O

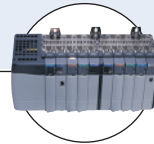

**PLC**

- Indication, monitoring, transmitting and On/Off control in one device
- Extra-large display
- Menu-guided parametrisation
- Complete communication due to external setpoint, process value

This intelligent sensor/switch with an extra-large display is specifically designed to switch a valve and to establish a monitoring system or an ON/OFF control loop.

Compact and wall versions are available. The wall-mounted version must be inserted into a holder previously mounted on a wall, and it must be associated with a remote temperature sensor.

The switching points can be programmed with the 3 key pads or optionally, with input 4 - 20 mA, from an external PLC over a 4 - 20 mA loop.

As an option, the process value can additionally be transmitted to the PLC (4 - 20 mA).

The connection of the 8400 to the process in the piping is made using standard fittings.

### General data

#### Materials

Housing	PC, +20% glass fibre
Front panel folio / Screws	Polyester / Stainless steel
Cable plug, Multipin	PA
Wall-mounted holder	PVC
Materials wetted parts	
Sensor element	Stainless steel
Seal	FKM

**Sensor element** Pt100

**Screw-in thread** G, NPT, Rc 1/2"

**Electrical connections** Cable plug: EN 175301-803  
Multipin: swivel M12, 5-pin or M12, 4-pin or 8-pin

**Voltage supply cable** max. 100 m, shielded, 0.14 up to 0.5 mm<sup>2</sup> max.  
5 Ω max. cable impedance (Wall-mounted version)

### Complete device data (pipe + electronic module)

<b>Pipe diameter</b>	Any pipe with sensor connection 1/2"
<b>Measuring range</b>	
Compact version	-40 up to +125°C (-40 to 257°F) (with ambient temperature between 0 and +40°C (-32 and 104°F))
Wall-mounted version	-40 up to +90°C (-40 to 194°F) (with ambient temperature above +40°C (104°F)) -40 up to +125°C (-40 to 257°F)
<b>Medium temperature</b>	+125°C max. (257°F)
<b>Fluid pressure max.</b>	PN16
<b>Switching accuracy</b>	±0.5°C (0.9°F)(0 up to +80°C (32 to 176°F)) ±1.5°C (2.7°F)(outside of 0 up to +80°C (32 to 176°F))
<b>Repeatability</b>	≤ ±0.4%

Electrical data	
<b>Power supply</b>	12-30 V DC , filtered and regulated
<b>Outputs</b>	
Compact version	
Transistor (programmable)	NPN and PNP, open collector, 5 up to 30 V DC, 700 mA max., protected against short circuits
Relay (programmable)	3A/250 V AC or 3A/30 V DC 3A/48 V AC or 3A/30 V DC <sup>1)</sup>
Process value (option)	4-20 mA, galvanic insulation Loop resistance: 1000 Ω at 30 V DC, 800 Ω at 24 V DC, 500 Ω at 18 V DC
Wall-mounted version	NPN and PNP, 700 mA, 30 VDC max.
<b>Input external setpoint</b>	
Compact version	4-20 mA, galvanic insulation, max. input impedance: 250 Ω
<b>Current consumption</b>	
Compact version	Max. 80 mA (no load)
Wall-mounted version	Max. 50 mA (no load)
<b>Response time (10...90%)</b>	7 s (for one step increment from 0 up to 100°C (32 to 212°F))
<b>Reversed polarity of DC</b>	Protected

Environment	
<b>Ambient temperature</b>	-20 up to 60°C (4 to 140°F)
<b>Relative humidity</b>	≤ 80%, without condensation

Standards, directives and approvals	
<b>Protection class</b>	IP65 with connector plug-in
<b>Standards and directives</b>	
EMC	EN 50081-1, 50082-2
Security	EN 61010-2
Pressure	Complying with article 3 of §3 from 97/23/CE directive.*
Vibration	EN 60068-2-6
Shock	EN 60068-2-27

\* For the 97/23/CE pressure directive, the device can only be used under following conditions (depend on max. pressure, pipe diameter and fluid).

Type of fluid	Conditions
Fluid group 1, §1.3.a	DN ≤ 50
Fluid group 2, §1.3.a	DN ≤ 50
Fluid group 1, §1.3.b	DN ≤ 50
Fluid group 2, §1.3.b	DN ≤ 50

1) Valid for: external setpoint input and process value output

## Main features

### Display

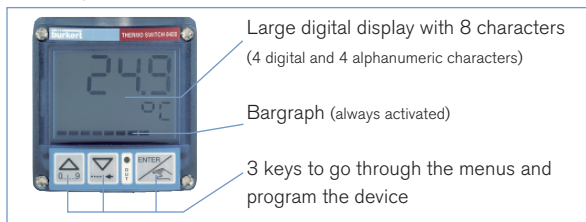

### Software main features

- International measuring units
- 10-segment bargraph
- Temperature adjusting for a better accuracy
- Simulation mode to test the programming of the switching points, in dry conditions

### 8400 with external setpoint

- The switching points are automatically adjusted by the 4-20 mA input signal originating from a PLC.
- On/Off relay output

### 8400 with process value option

- This version delivers a 4-20 mA electric signal whose value is the image of the measured temperature
- On/Off relay output
- 4-20 mA output
- External setpoint (4-20 mA input)

### 8400 with standard On/Off output

- 2 switching modes for the output, either hysteresis or window, inverted or not

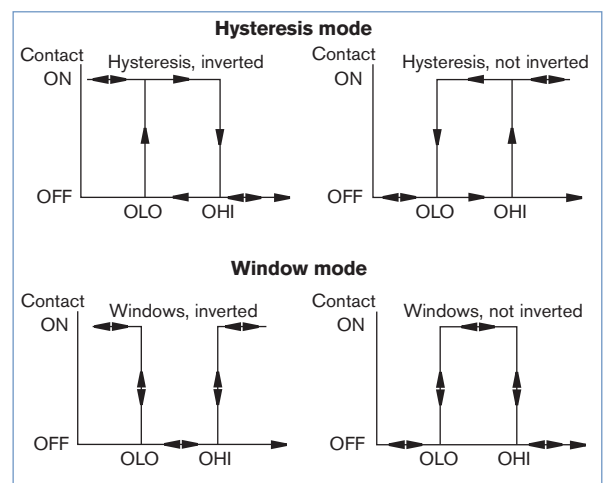

- Programmable delay before switching
- Possible outputs depending on the version: relay, transistor NPN or transistor PNP

**Design**

The 8400 Temperature sensor is proposed in two versions:



A compact version, available in several variants.

- The 8400 Standard has a Pt100 with a 29.5 mm mounting length.

- The 8400 Extended has a Pt100 with a 100 or 200 mm mounting length. The adaptation of the 8400 will be done through the external thread or also with a compression fitting (no part of delivery).

This allows variable mounting in bigger pipe diameters or tanks.



wall-mounted version:

- The 8400 Wall has to be inserted into a holder previously mounted on a wall. It must be associated to a remote temperature sensor.

**Typical application example**

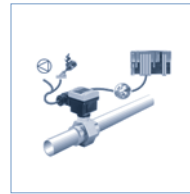

Monitoring of min./max. levels of temperature in a running process (compact INLINE control)



Continuous temperature control in a running process

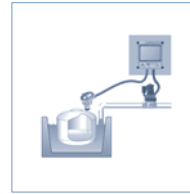

On/Off temperature control of liquid processing in a programmable narrow band (remote control)

**Dimensions**

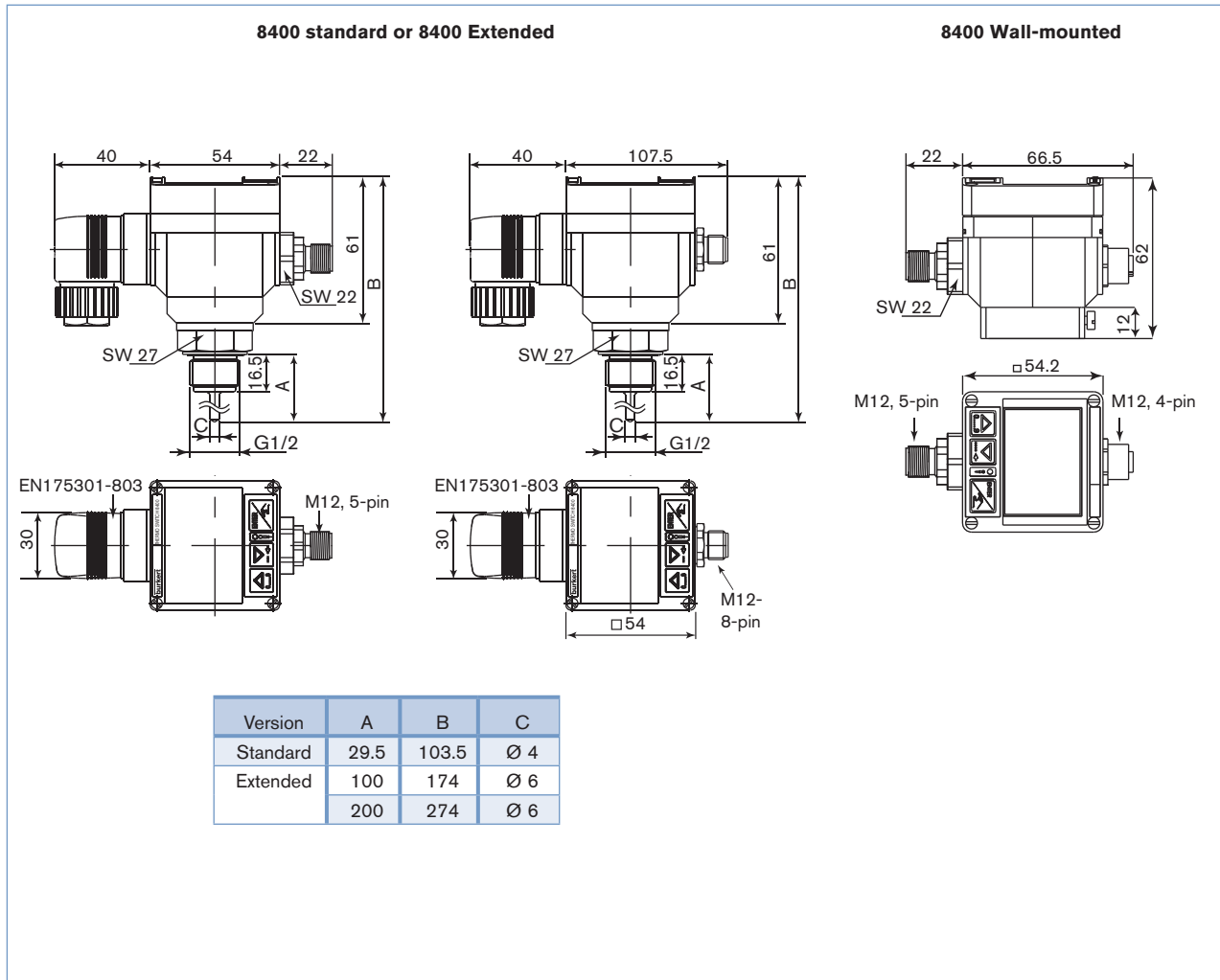

## Ordering chart for Type 8400 (other versions on request)

Sensor version	Sensor element	Voltage supply	Screw-in thread	Input	Output	Connector	Item no.
Standard, compact	29.5 mm - ø 4 mm	12-30 V DC	G1/2"	-	NPN and PNP	5-pin swivel M12 plug	436 501
					Relay	5-pin swivel M12 plug and cable plug EN 175301-803*	436 503
				4-20 mA <sup>1)</sup>	4-20 mA <sup>2)</sup> + Relay	8-pin M12 plug and cable plug EN 175301-803*	444 696
					NPN and PNP	5-pin swivel M12 plug	436 507
			NPT1/2"		Relay	5-pin swivel M12 plug and cable plug EN 175301-803*	436 509
				4-20 mA <sup>1)</sup>	4-20 mA <sup>2)</sup> + Relay	8-pin M12 plug and cable plug EN 175301-803*	444 698
					NPN and PNP	5-pin swivel M12 plug	436 504
					Relay	5-pin swivel M12 plug and cable plug EN 175301-803*	436 506
Extended, compact	100 mm - ø 6 mm	12-30 V DC	G1/2"	-	Relay	5-pin swivel M12 plug and cable plug EN 175301-803*	550 053
					4-20 mA <sup>2)</sup> + Relay	8-pin M12 plug and cable plug EN 175301-803*	550 055
			G1/2"	-	Relay	5-pin swivel M12 plug and cable plug EN 175301-803*	550 054
					4-20 mA <sup>2)</sup> + Relay	8-pin M12 plug and cable plug EN 175301-803*	550 056
Wall-mounted	-	12-30 V DC	-	3-wired Pt100	NPN and PNP	5-pin swivel M12 male and 4-pin M12 female	448 862

1) Ext. Setpoint

2) Process value

\*) EN 175301-803

Europe /Asia (G / Rc) : M16 x 1.5mm cable plug  
USA/ CDN (NPT): NPT 1/2 cable plug

The adaptation of the 8400 will be done through the external thread or also with a compression fitting (no part of delivery). This allows variable mounting in bigger pipe diameters or tanks.

## Ordering chart for accessories (to be ordered separately)

Description	Item no.
5-pin M12 female cable connector with plastic threaded locking ring	917 116
5-pin M12 female connector moulded on cable (2 m, shielded)	438 680
4-pin M12 male cable connector with plastic threaded locking ring	448 856
4-pin M12 male connector moulded on cable (2 m, shielded)	448 857
8-pin M12 female cable connector with plastic threaded locking ring	444 799
8-pin M12 female connector moulded on cable (2 m, shielded)	444 800
Cable plug EN 175301-803 with cable gland (Type 2508)	438 811
Cable plug EN 175301-803 with NPT1/2" reduction without cable gland (Type 2509)	162 673

To find your nearest Bürkert facility, click on the orange box →

[www.burkert.com](http://www.burkert.com)In case of special application conditions,  
please consult for advice.Subject to alteration.  
© Christian Bürkert GmbH & Co. KG

0907/5\_EU-en\_00891877