

VAL-MATIC®

Silent Operation
Proven Performance
Cost Effective

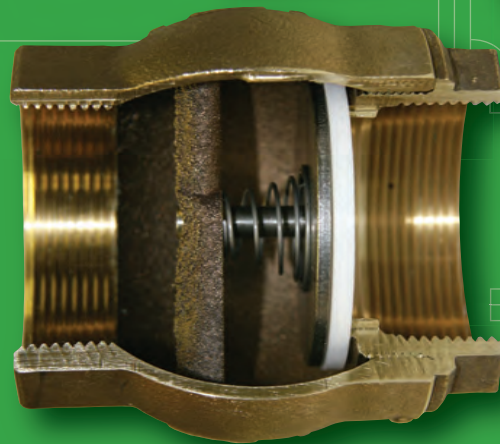

Silent Check
Valves

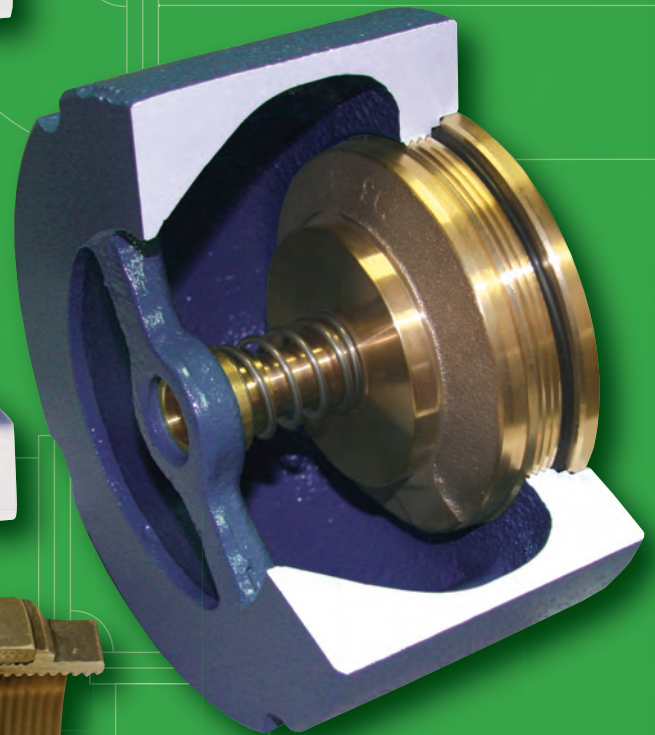

www.valmatic.com

Certified Lead-Free
NSF/ANSI 61 & 372 Certified

Feature Highlights

Threaded

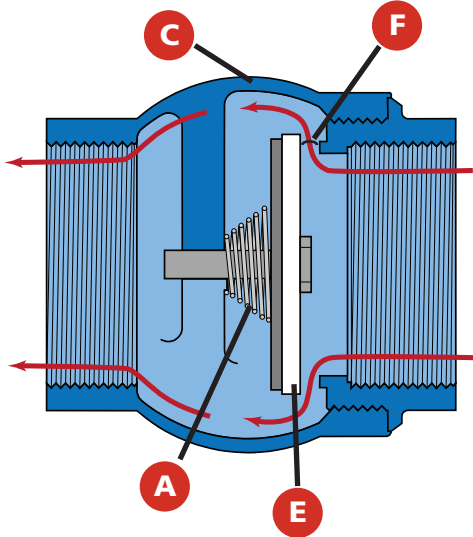

Wafer

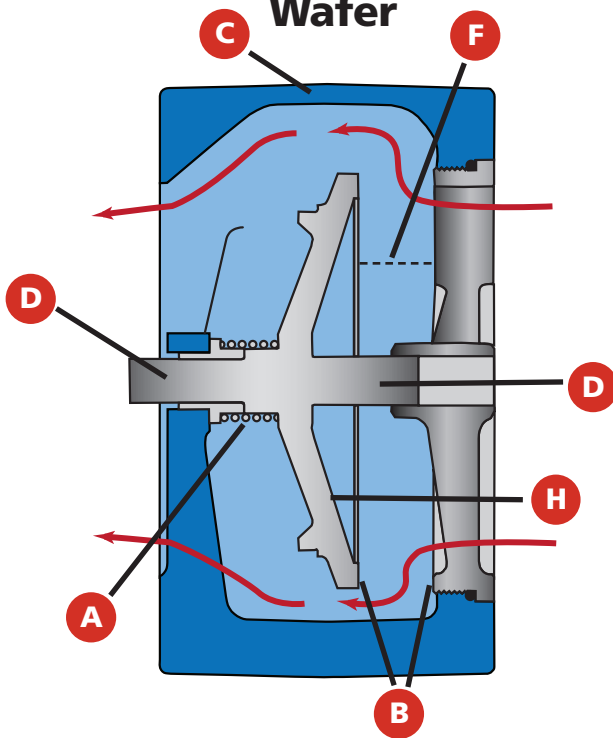

Globe

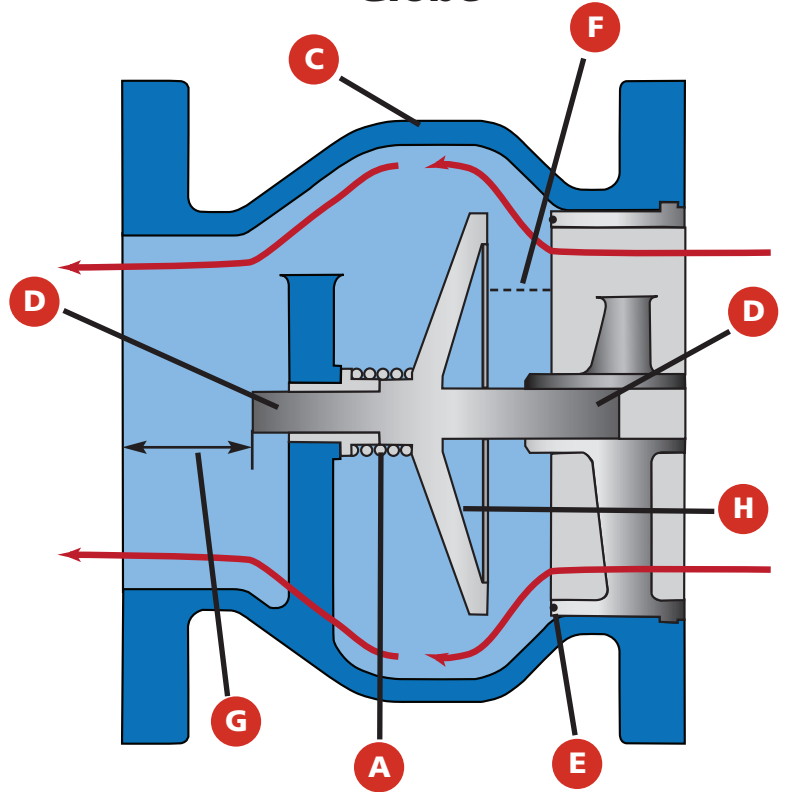

A. Heavy Duty Spring

Cycle tested over 100,000 times to ensure valve dependability and non-slam closure.

B. Metal-to-Metal Seating

For durability and extended life. Corrosion free seat and disc sealing surfaces are precision-machined flat and smooth to meet AWWA and MSS metal seat leakage criteria.

C. Expanded Flow Area

Tear-drop contour reduces headloss and provides energy savings.

D. Double Guided Disc

Prevents vibration and wear, ensuring long valve life.

E. Resilient Seat

Provides zero leakage. Standard on Threaded style, available on Wafer and Globe styles.

F. Short Stroke

The combination of short stroke and spring return assures non-slam closure.

G. Mate-ability

Globe style sizes 2½ through 10 in. mate to wafer style butterfly valves without the use of spool pieces.

H. Concave Disc

Concave to flow direction providing for disc stabilization, maximum strength and a minimum flow velocity to open the valve.

Features & Benefits

The Val-Matic Silent Check Valve has been the preferred choice by users for over 46 years. Its silent operation, low cost and proven performance in clean water applications has made it a favorite by design engineers and system operators.

Silent Operation

The Silent Check Valve is preferred over other types of valves because of its silent operation which reduces shock and water hammer. The Silent Check Valve is the fastest closing check valve because of its short stroke and spring-assisted closure. When flow occurs, the disc is lifted off the seat to allow forward flow. When the pump is stopped, the spring in the valve forces the disc closed before flow reverses, providing silent closure. Dynamic check valve tests show that surge pressure is significantly reduced when a silent check valve is used. (See Figures 1 & 2)

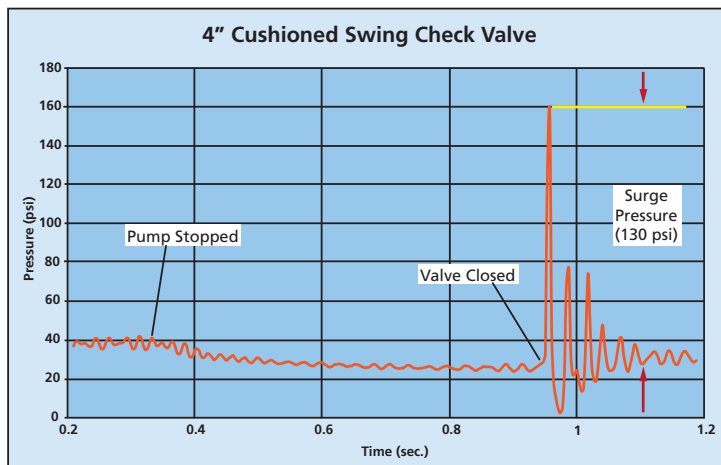

Figure 1 - Cushioned Swing Check Valve Dynamic Test Results

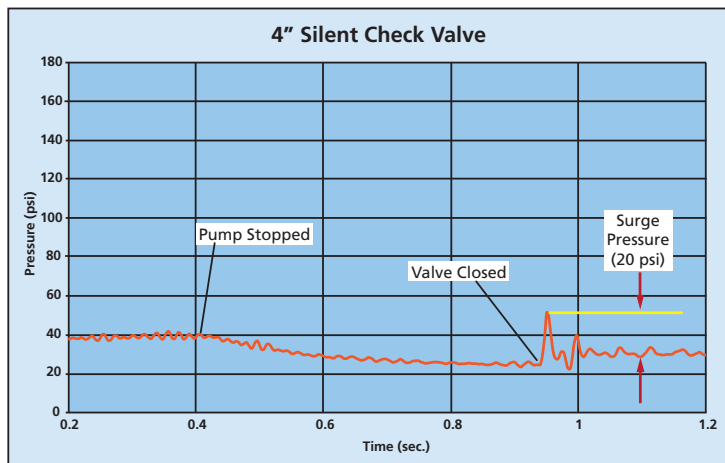

Figure 2 - Silent Check Valve Dynamic Test Results

Optional Resilient Seat

The Val-Matic Wafer and Globe Silent Check Valves incorporate an optional disc/seat design that provides zero leakage and reduces the potential for o-ring seal damage. The unique seating action begins with the initial contact between the metal valve disc and the

resilient o-ring providing a low pressure seal (See Figure 3). As pressure increases, the resilient seal is compressed which allows the disc to make contact with the metal portion of the valve seat (See Figure 4). This combined with excess area in the o-ring groove prevents over compression of the synthetic seal. The design also provides disc seal overlap of the resilient seal to prevent indentation ridges that can cause leakage and seal damage.

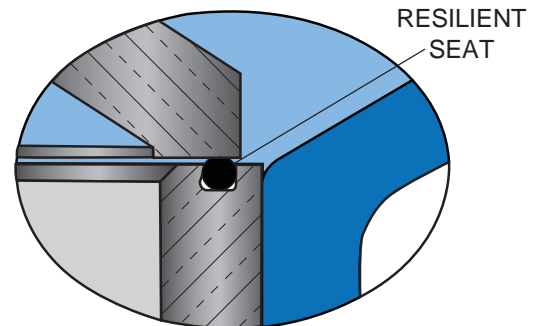

Figure 3 - Resilient Seating Detail at Low Pressure

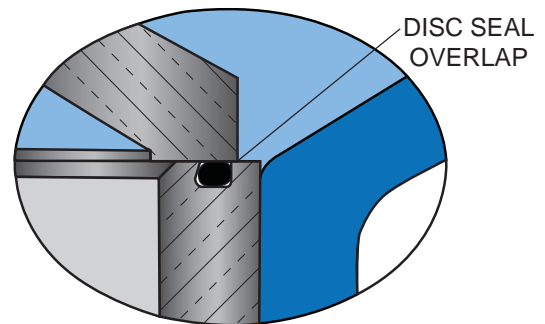

Figure 4 - Resilient Seating Detail at High Pressure

Installation Versatility

All three styles of Silent Check Valves can be installed in either horizontal or vertical lines with the flow up or down.* The operation of the valve is not affected by its installation position. Sizes 2 - 6 in. are dual rated to fit between both ANSI Class 125 and 250 flanges. In applications where space is limited, the compact wafer style is the preferred choice. Globe Style Silent Check Valves in sizes 2½ - 10 in. are able to mate to wafer style butterfly valves without the use of spool pieces or any other adaptors. (See Illustration on page 5.)

Product Certifications

Val-Matic Silent Check Valves are NSF/ANSI 372 certified Lead-Free and are NSF/ANSI 61 certified for drinking water. Wafer style (2-10 in.) and Globe style (2½-12 in.) Silent Check Valves are Factory Mutual approved for use in fire protection systems. All Val-Matic Valves are manufactured under a certified ISO 9001 quality management system.

*Note: Valves 14" and larger require a heavy duty spring for flow down applications.

Installation Dimensions

Series 1400THR - Threaded

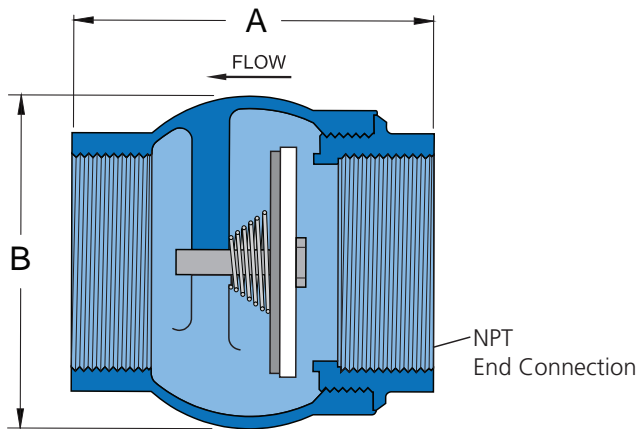

Dimensions				
Valve Size (NPT)	CWP psig (Bar)	A in (mm)	B in (mm)	Weight lb (kg)
1/2	250 (17.2)	2.06 (52.3)	1.38 (35.0)	.38 (.17)
3/4	250 (17.2)	2.25 (57.1)	1.63 (41.4)	.48 (.22)
1	250 (17.2)	2.63 (66.8)	2.00 (50.8)	.81 (.37)
1 1/4	250 (17.2)	2.94 (74.6)	2.38 (60.4)	1.22 (.55)
1 1/2	250 (17.2)	3.31 (84)	2.75 (69.8)	1.61 (.73)
2	250 (17.2)	3.68 (93.4)	3.38 (85.8)	5.13 (2.33)

Series 1400A - Wafer

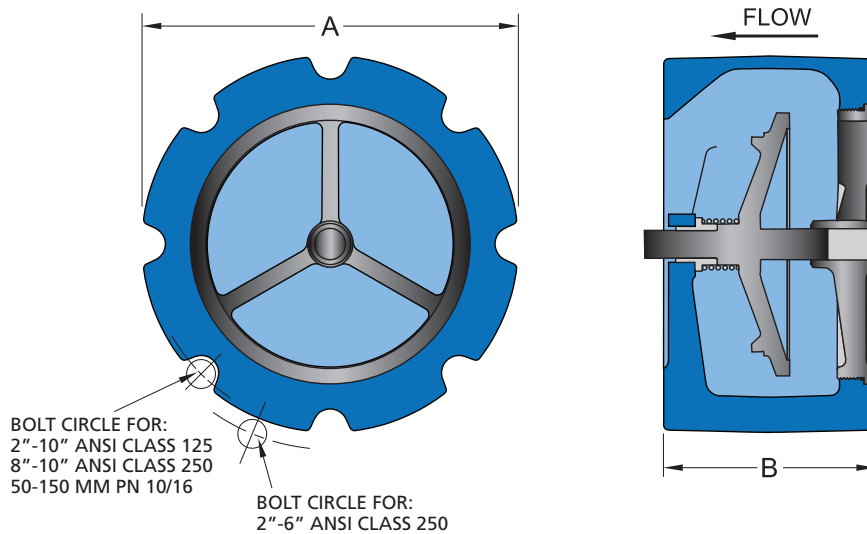

Dimensions - Inch					
Valve Size	CWP (psig)	ANSI Class	A	B	Weight (lb)
2*	400	125/250	4.25	2.63	6
2 1/2*	400	125/250	5.00	2.88	7
3*	400	125/250	5.75	3.13	11
4*	400	125/250	7.00	4.00	19
5*	400	125/250	8.75	4.75	28
6*	400	125/250	9.75	5.50	41
8	200	125	13.38	6.50	81
	400	250	13.38	6.50	89
10	200	125	16.00	8.25	99
	400	250	16.00	8.25	137

Dimensions - Metric					
Valve Size	CWP (Bar)	PN Class	A	B	Weight (kg)
50	27.6	10/16	107.9	66.8	3
65	27.6	10/16	127	73.1	4
80	27.6	10/16	146	79.5	5
100	27.6	10/16	177.8	101.6	9
125	27.6	10/16	222.2	107.9	13
150	27.6	10/16	247.6	139.7	19

*Note: Sizes 2 - 6 in. are dual rated to fit between both ANSI Class 125 and 250 flanges.

Installation Dimensions

Series 1800 - Globe

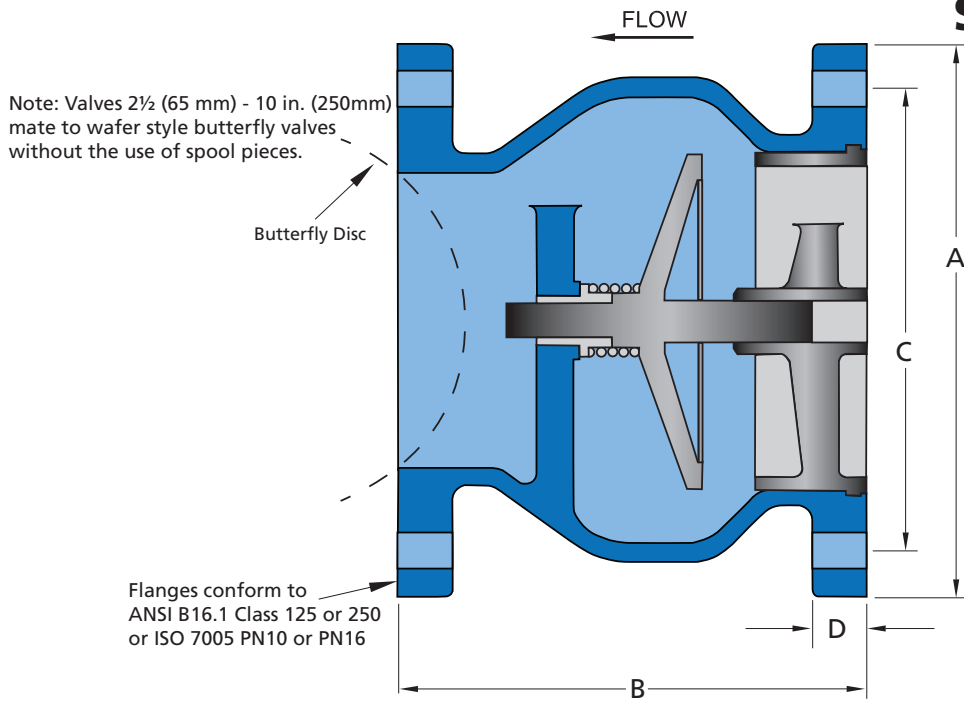

Dimensions - Inch							
Valve Size	CWP (psig)	ANSI Class	A	B	C	D	Weight (lb)
2 1/2	200	125	7.00	5.50	5.50	0.69	19
	400	250	7.50	5.50	5.88	1.00	30
3	200	125	7.50	6.00	6.00	0.94	28
	400	250	8.25	6.00	6.63	1.13	36
4	200	125	9.00	7.25	7.50	0.94	43
	400	250	10.00	7.25	7.88	1.25	59
5	200	125	10.00	8.50	8.50	0.94	55
	400	250	11.00	8.50	9.75	1.38	78
6	200	125	11.00	9.75	9.50	1.00	78
	400	250	12.50	9.75	10.63	1.44	103
8	200	125	13.50	12.50	11.75	1.13	102
	400	250	15.00	12.50	13.00	1.63	179
10	200	125	16.00	15.50	14.25	1.19	208
	400	250	17.50	15.50	15.25	1.88	253
12	200	125	19.00	14.25	17.00	1.25	294
	400	250	20.50	14.25	17.75	2.00	401
14	150	125	21.00	15.75	18.75	1.38	380
	300	250	23.00	15.75	20.25	2.13	511
16	150	125	23.50	17.63	21.25	1.44	501
	300	250	25.50	17.63	22.50	2.25	697
18	150	125	25.00	18.75	22.75	1.56	724
	300	250	28.00	18.75	24.75	2.38	959
20	150	125	27.50	20.63	25.00	1.69	890
	300	250	30.50	20.63	27.00	2.50	1,180
24	150	125	32.00	24.00	29.50	1.88	1,220
	300	250	36.00	24.00	32.00	2.75	1,680
30	150	125	38.75	29.25	36.00	2.13	2,100
	300	250	43.00	29.25	39.25	3.00	2,700
36	150	125	46.00	45.00	42.75	2.38	4,400
	300	250	50.00	46.00	46.00	3.38	5,100
42	150	125	53.00	50.00	49.50	2.63	7,200
	300	250	57.00	50.00	52.75	3.69	7,900

Dimensions - Metric							
Valve Size	CWP (Bar)	PN Class	A	B	C	D	Weight (kg)
65	16	10/16	178	140	145	18	9
80	16	10/16	192	152	160	24	13
100	16	10/16	220	184	180	24	20
125	16	10/16	250	216	210	24	25
150	16	10/16	285	248	240	25	35
200	16	10	340	318	295	29	46
	16	16	340	318	295	29	81
250	16	10	395	362	350	30	94
	16	16	405	362	355	30	114
300	16	10	445	394	400	32	133
	16	16	460	394	410	32	181
350	10	10	505	400	460	35	172
	16	16	520	400	470	35	231
400	10	10	565	448	515	37	227
	16	16	580	448	525	37	316
450	10	10	615	476	565	40	328
	16	16	640	476	585	40	434
500	10	10	670	524	620	43	403
	16	16	715	524	650	43	535
600	10	10	780	610	725	48	553
	16	16	840	610	770	48	762

Valve Construction

PRESSURE RATINGS

MAXIMUM PRESSURE RATINGS				
SERIES	DESCRIPTION	SIZE RANGE	END CONNECTION	CWP psig (Bar)
1400THR	Threaded	1/2" - 2" (15-50mm)	Threaded NPT	250 (17.2)
1400A	Wafer Style	2" - 6" (50-150mm)	Wafer Class 125/250	400 (27.6)
		8" - 10" (200-250mm)	Wafer Class 125	200 (13.8)
		8" - 10" (200-250mm)	Wafer Class 250	400 (27.6)
1800	Globe Style	2 1/2" - 12" (65-250mm)	Flanged Class 125	200 (13.8)
		14" - 42" (300-1050mm)	Flanged Class 125	150 (10.3)
		2 1/2" - 12" (65-250mm)	Flanged Class 250	400 (27.6)
		14" - 42" (300-1050mm)	Flanged Class 250	300 (20.7)

MATERIALS OF CONSTRUCTION

Threaded Style

COMPONENT	STANDARD
Body	Lead-Free Bronze
Disc	Lead-Free Bronze
Seat	Teflon
Spring	T316 Stainless Steel

Wafer & Globe Style

COMPONENT	STANDARD	OPTIONAL
Body	Cast Iron	Stainless Steel Ductile Iron
Disc	Lead-Free Bronze	Al-Bronze (Lead-Free) Stainless Steel
Seat	Lead-Free Bronze	Al-Bronze (Lead-Free) Stainless Steel
Resilient Seat	-	Buna-N EPDM
Spring	T316 Stainless Steel	Heavy Duty Spring

Headloss Chart

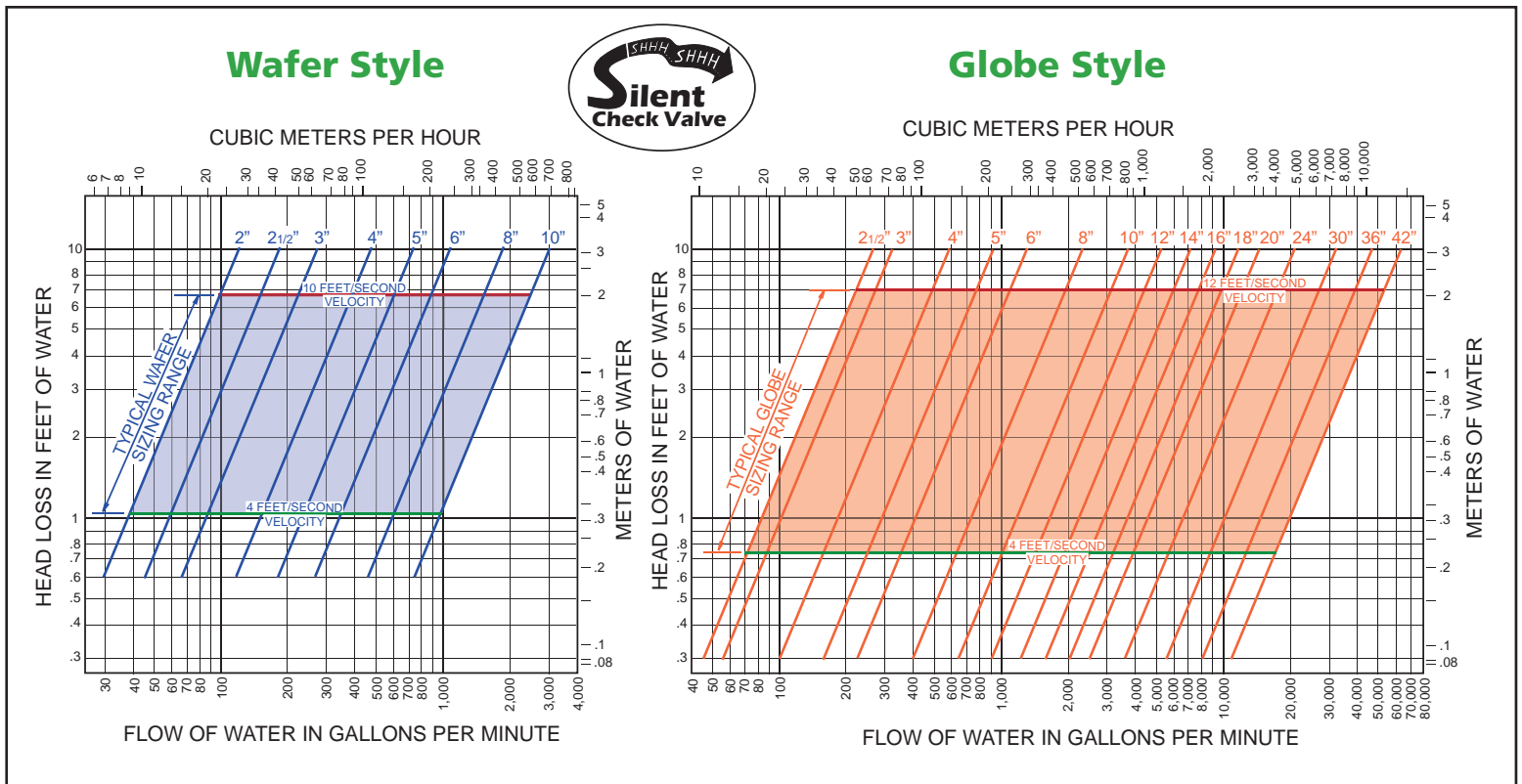

Size	2	2-1/2	3	4	5	6	8	10	12	14	16	18	20	24	30	36	42
Wafer Cv	43	88	130	228	350	520	900	1450	-	-	-	-	-	-	-	-	-
Globe Cv	-	127	155	278	435	625	1115	1770	2500	3400	4400	5600	6900	10,000	15,400	22,400	30,400

SCOPE

- 1.1 This specification covers the design, manufacture, and testing of 1/2 in. (15 mm) through 2 in. (50 mm) Bronze Threaded Silent Check Valves, 2 in. (50 mm) through 10 in. (250 mm) Wafer Silent Check Valves and 2 1/2 in. (65 mm) through 42 in. (1050 mm) Globe Silent Check Valves suitable for pressures up to 500 psig (3450 kPa) water service.
- 1.2 The Check Valve shall be of the silent operating type that begins to close as the forward flow diminishes and fully closes at zero velocity preventing flow reversal and resultant water hammer. The dynamic characteristics of the valve shall be published and verified by independent laboratory test data.

STANDARDS AND APPROVALS

- 2.1 The valves for use in fire protection systems shall be Factory Mutual approved in Wafer Style sizes 2 in.- 6 in. Class 125/250, 8 in.- 10 in. Class 125 and Globe Style 2 1/2 in.- 10 in. Class 125/250, 12 in. Class 125.
- 2.2 Stainless steel valves shall meet the requirements of ASME B16.34 and MSS SP-126.
- 2.3 The valves used in potable water service shall be certified to NSF/ANSI 61, Drinking Water System Components – Health Effects, and certified to be Lead-Free in accordance with NSF/ANSI 372.
- 2.4 Manufacturer shall have a quality management system that is certified to ISO 9001 by an accredited, certifying body.

CONNECTIONS

- 3.1 Threaded Style valves shall be provided in sizes 1/2 in. (15mm) through 2 in. (50mm) and have a two-piece body with female threaded NPT ends.
- 3.2 Globe style valves shall be provided in sizes 2 1/2 in. (65 mm) through 42 in. (1050 mm) and have flat faced flanges in accordance with ASME B16.1 for Class 125 or Class 250 iron flanges or in sizes 65 mm to 600 mm in accordance with ISO 7005 PN10 or PN16. Sizes 10 in. (250 mm) and smaller flanged valves shall be capable of mating directly to a wafer butterfly valve without disc interference.
- 3.3 Wafer style valves shall be provided in sizes 2 in. (50 mm) through 10 in. (250 mm) for installation between ASME B16.1 Class 125 or Class 250 iron flanges or sizes 50 mm to 100 mm in accordance with ISO 7005 PN10 or PN16. Stainless steel wafer style valves shall include raised faces for installation between ASME B16.5 Class 150 flanges.

DESIGN

- 4.1 The valve design shall incorporate a center guided, spring loaded disc and have a short linear stroke that generates a flow area equal to the nominal valve size.
- 4.2 The operation of the valve shall not be affected by the position of installation. The valve shall be capable of operating in the horizontal or vertical positions with the flow up or down. Heavy duty springs for vertical flow down installations shall be provided when specified on 14 in. and larger valves.
- 4.3 All component parts shall be field replaceable without the need of special tools. Wafer and Globe styles shall be provided with a replaceable guide bushing held in position by the spring. The spring shall be designed to withstand 100,000 cycles without failure and provide a cracking pressure of 0.5 psi.

- 4.4 The wafer and globe disc shall be concave to the flow direction providing for disc stabilization, maximum strength, and a minimum flow velocity to open the valve.
- 4.5 The valve disc and seat shall have a seating surface finish of 16 micro-inch or better to ensure positive seating at all pressures. The leakage rate shall not exceed the allowable rate for metal seated valves allowed by AWWA C508 and MSS SP-125 or 1 fl oz (30 ml) per hour per inch of nominal size.
- 4.6 Wafer-style valve seats shall be fully retained with full size threads, and sealed with an o-ring. Globe style valve seats shall be contained with a machined counterbore and restrained by the mating flange and gasket.

MATERIALS

- 5.1 The threaded valve body and disc shall be ASTM B584 copper alloy C87600 lead-free bronze. The seat shall be TFE. The spring shall be Type 316 stainless steel.
- 5.2 Globe and wafer valve bodies shall be constructed of ASTM A126 Class B cast iron for Class 125 and Class 250 valves and ASTM A351 Grade CF8M for Class 150 stainless steel valves. Optional body material includes ASTM A536 Grade 65-45-12 ductile iron.
- 5.3 Globe and wafer seat and disc shall be ASTM B584 Alloy C83600 cast bronze or ASTM B148 Alloy C95200 aluminum bronze. Optional trim material includes ASTM B584 copper alloy C87600 lead-free bronze or ASTM A351 Grade CF8M stainless steel.
- 5.4 Globe and wafer compression spring shall be ASTM A313 Type 316 stainless steel with ground ends.

OPTIONS

- 6.1 A resilient seal shall be provided on the seat when specified to provide zero leakage at both high and low pressures without overloading or damaging the seal. The seal design shall provide both a metal-to-metal and a metal-to-resilient seal.
- 6.2 Valve interiors and exteriors shall be coated with an NSF/ANSI 61 certified fusion bonded epoxy in accordance with AWWA C550 when specified.

MANUFACTURE

- 7.1 The valves shall be hydrostatically tested at 1.5 times their rated cold working pressure and seat tested at the valve CWP. When requested, the manufacturer shall provide test certificates, dimensional drawings, parts list drawings, and operation and maintenance manuals.
- 7.2 The exterior of the valve shall be coated with a universal alkyd primer.
- 7.3 Silent Check Valves shall be Series #1400THR.1 (Threaded Style), Series #1400A (Wafer Style) or 1800 (Globe Style) as manufactured by Val-Matic® Valve & Mfg. Corporation, Elmhurst, IL. USA or approved equal.

VAL-MATIC®

Val-Matic's quality of design and meticulous workmanship has set the standards by which all others are measured. Quality design features such as the AWWA **Ener•G® Ball Valve** with its energy efficient design, fusion bonded epoxy and adjustable resilient seating....**Cam-Centric® Plug Valves** have more requested features than any other eccentric plug valve....**American-BFV® Butterfly Valves** include a field replaceable seat without the need for special tools....**Tilted Disc® Check Valves** with high strength and wear resistant aluminum bronze trim as standard....**Silent Check Valves** featuring combined resilient/metal-to-metal seating and are **NSF/ANSI 61 & 372 Certified**....**Sure Seal Foot Valves** provided with a heavy duty stainless steel screened inlet....**Swing-Flex® and Surgebuster® Check Valves** designed with an unrestricted full flow area....**Dual Disc® Check Valves** utilizing stabilized components to provide extended life....**Air Release, Air/Vacuum and Combination Air Valves** provided standard with Type 316 stainless steel trim....**VaultSafe®** family of products includes the **FloodSafe® Inflow Preventer, FrostSafe®** two-way damper and the **VentSafe®** vent pipe security cage. These features coupled with our attention to detail put Val-Matic Valves in a class by themselves. All products are certified Lead-Free.

Val-Matic is totally committed to providing the highest quality valves and outstanding service to our customers. Complete customer satisfaction is our goal.

Make the Change to Quality!

Specify

VAL-MATIC®

Val-Matic Valve and Manufacturing Corp.
905 Riverside Drive, Elmhurst, IL 60126
Phone: 630-941-7600 Fax: 630-941-8042
www.valmatic.com
valves@valmatic.com

Copyright © 2012 Val-Matic Valve & Mfg. Corp.
ISO 9001:2008 certified company

