

- > **Port size: 3/4" ... 1 1/2" (ISO G/PTF)**
- > **Olympian relief valves protect compressed air systems from over-pressurisation**
- > **High relief capacity, sensitive and accurate**
- > **Threaded relief port for silencer or piped exhaust**



### Technical features

#### Medium:

Compressed air only

#### Maximum operating pressure:

20 bar (290 psi)

#### Outlet pressure adjustment range:

Standard

0,3 ... 10 bar (4 ... 145 psi)

Optional

0,3 ... 4 bar (4 ... 58 psi),

0,7 ... 17 bar (10 ... 246 psi)

#### Port sizes:

3/4", 1", 1 1/4" or 1 1/2"

#### Gauge port:

1/8 PTF with PTF main ports

Rc1/8 with ISO G main ports-

#### Gauge ports:

Rc 1/8

#### Relief port:

1" PTF with PTF yoke ports

G1 with ISO G yoke ports

#### Ambient/Media temperature:

-20° ... +80°C (-4° ... +176°F)

Version with gauge:

-20° ... +65°C (-4° ... +149°F)

Air supply must be dry enough to avoid ice formation at temperatures below +2°C (+35°F).

#### Materials:

Body, bonnet & yoke: aluminium

Adjusting screw: steel

Elastomers: NBR

### Technical data - standard models

Symbol	Port size	Size	Pressure range (bar)	Weight (kg)	Model
	G3/4	—	0,3 ... 10	2,21	V68H-6GD-RMN
	G1	Basic	0,3 ... 10	2,20	V68H-8GD-RMN
	G1 1/4	—	0,3 ... 10	2,22	V68H-AGD-RMN
	G1 1/2	—	0,3 ... 10	2,26	V68H-BGD-RMN
	Without yoke	—	0,3 ... 10		V68H-NND-RMN

### Option selector

Port size	Substitute
3/4"	<b>6</b>
1"	<b>8</b>
1 1/4"	<b>A</b>
1 1/2"	<b>B</b>
Without yoke (standard)	<b>N</b>
Thread	Substitute
PTF	<b>A</b>
ISO G parallel (standard)	<b>G</b>

### V68H-★★D-R★★

Gauge	Substitute
With	<b>G</b>
Without (standard)	<b>N</b>
Spring (Outlet Pressure Range) *1)	Substitute
0,3 ... 10 (standard)	<b>M</b>
0,3 ... 4	<b>F</b>
0,7 ... 17	<b>S</b>

\*1) Relief valves can be adjusted to pressures in excess of, and less than, those specified. Do not use these units to control pressures outside of the specified ranges.

## Flow characteristics

### Unported

Pressure range 1 ... 10 bar (15 ... 145 psi)

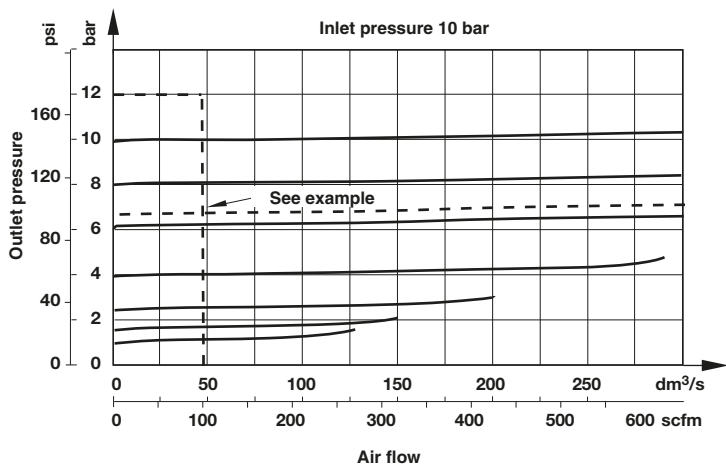

### How to select a relief valve

The function of a relief valve is to help prevent an over pressure condition that could result in damage to downstream equipment. Typically, a pressure regulator reduces the supply pressure from the air compressor to a suitable working pressure. The relief valve is installed downstream of the regulator to protect downstream equipment from high pressure spikes.

Flow capacity of the relief valve selected must equal or exceed the flow and pressure rating of the air compressor.

### EXAMPLE:

If your compressor delivers 47 dm<sup>3</sup>/s (100 scfm) at 12 bar (175 psi) and your system requires a working pressure of 6.2 bar (90 psi), the relief valve must have a set pressure slightly higher than the 6.2 bar (90 psi) working pressure and be capable of flowing 47 dm<sup>3</sup>/s (100 scfm) at 12 bar (175 psi), or pressures less than 12 bar (175 psi).

## Accessories

	Single yoke	Double yoke	End connector kit	Single yoke non threads	3/2 Shut-off valve Threaded inlet only	Threaded outlet only	Bracket mounting
<b>Thread</b>							
G3/4	Y68A-6GN-N1N	Y68A-6GN-N2N	5524-55	74785-98	T68H-6GB-B2N	T68H-6GC-B2N	18-001-979
G1	Y68A-8GN-N1N	Y68A-8GN-N2N	5524-52		T68H-8GB-B2N	T68H-8GC-B2N	18-001-979
G1 1/4	Y68A-AGN-N1N	Y68A-AGN-N2N	5523-52		T68H-AGB-B2N	T68H-AGC-B2N	18-001-978
G1 1/2	Y68A-BGN-N1N	Y68A-BGN-N2N	5523-93		T68H-BGB-B2N	T68H-BGC-B2N	18-001-972
3/4 PTF	Y68A-6AN-N1N	Y68A-6AN-N2N	5524-53		T68H-6AB-B2N	T68H-6AC-B2N	18-001-979
1 PTF	Y68A-8AN-N1N	Y68A-8AN-N2N	5524-50		T68H-8AB-B2N	T68H-8AC-B2N	18-001-979
1 1/4 PTF	Y68A-AAN-N1N	Y68A-AAN-N2N	5523-50		T68H-AAB-B2N	T68H-AAC-B2N	18-001-978
1 1/2 PTF	Y68A-BAN-N1N	Y68A-BAN-N2N	5523-95		T68H-BAB-B2N	T68H-BAC-B2N	18-001-972

Nut	Tamper resistant cover	Porting block	Silencer
5520-89	1581-90	18-026-986 (G1/4 & G1/2) 18-026-983 (1/4 & 1/2 NPT)	MB008B (R1) MB008A (1 NPT)

## Service kit

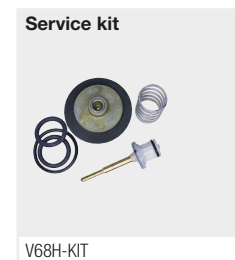

## Gauges

Center back connection, white face (full technical specification see datasheet 8.900.900)



Pressure range bar *1	MPa	psi	Ø	Thread size	Model
0 ... 4	0 ... 0,4	0 ... 58	50 mm	R1/8	18-013-011
0 ... 10	0 ... 1	0 ... 145	50 mm	R1/8	18-013-013
0 ... 25	0 ... 2,5	0 ... 362	50 mm	R1/8	18-013-014

Center back connection, black face for North America (full technical specification see datasheet 8.900.900)



Pressure range psig *1	bar	MPa	Ø	Thread size	Model
0 ... 60	0 ... 4	0 ... 0,4	2" (50 mm)	1/8 NPT	18-013-202
0 ... 160	0 ... 11	0 ... 1,1	2" (50 mm)	1/8 NPT	18-013-204
0 ... 400	0 ... 28	0 ... 2,8	2" (50 mm)	1/8 NPT	18-013-206

\*1) primary scale

\*1) primary scale

**Basic dimensions**

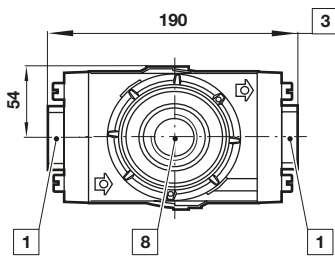
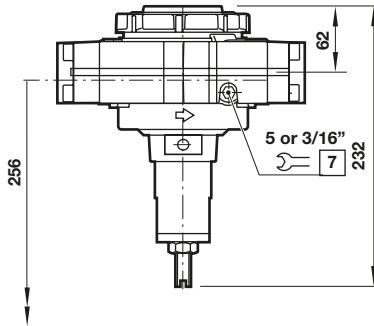
 Dimensions in mm  
 Projection/First angle

# Minimum clearance required to remove unit from yoke

- 1 Main ports 3/4", 1", 1 1/4" or 1 1/2"
- 3 Plus 10 mm for ports 1 1/4" or 1 1/2"
- 7 Gauge port 1/8"
- 8 Relief port 1"

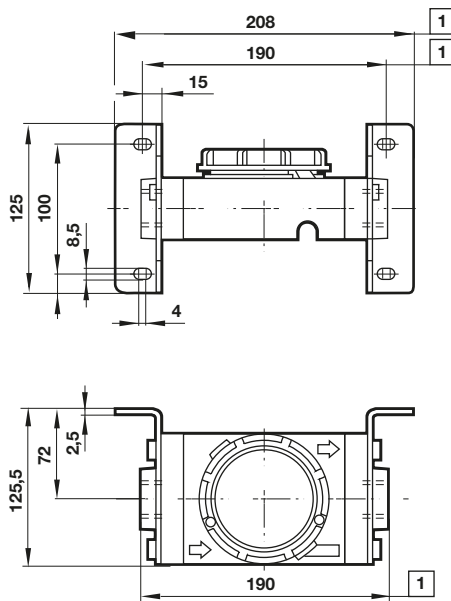
**Single yoke with bracket**

1 For 1 1/4" and 1 1/2" ported yokes add 10 mm

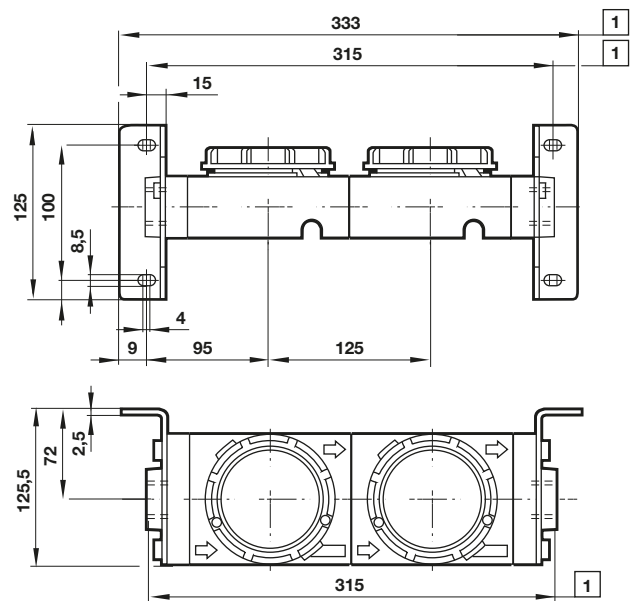
**Double yoke with bracket**

1 For 1 1/4" and 1 1/2" ported yokes add 10 mm

### 3/2 Shut-off valve

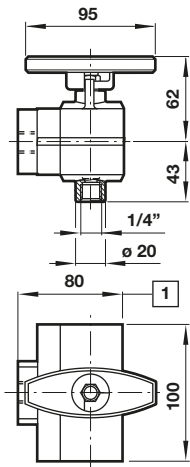

### Porting block

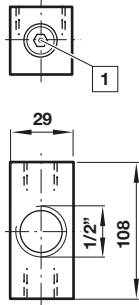

### Silencer

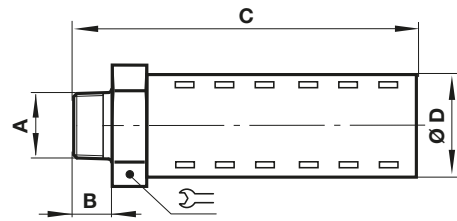

Dimensions in mm  
Projection/First angle



A	B	C	D		Model
R1	23	138	51	51	MB008B
1 NPT	23	138	51	51	MB008A

1 For 1 1/2" ported yokes add 5 mm

1 Two additional plugged G1/4 ports

## Warning

These products are intended for use in industrial compressed air systems only. Do not use these products where pressures and temperatures can exceed those listed under

### »Technical features/data«.

Before using these products with fluids other than those specified, for non-industrial applications, life-support systems or other applications not within published specifications, consult IMI Precision Engineering, IMI International s.r.o. Through misuse, age, or malfunction, components used in fluid power systems can fail in various modes.

The system designer is warned to consider the failure modes of all component parts used in fluid power systems and to provide adequate safeguards to prevent personal injury or damage to equipment in the event of such failure.

System designers must provide a warning to end users in the system instructional manual if protection against a failure mode cannot be adequately provided.

System designers and end users are cautioned to review specific warnings found in instruction sheets packed and shipped with these products.